

**SPECIFICATION**

Range: **LUCREZIO**  
Design: **Caimi Lab**

Description:

Sound-absorbing table composed of an hourglass structure made of painted steel rods, narrowed in the centre by a central band that visually divides it into two conical parts. The two parts contain sound-absorbing elements made of polyurethane and covered in Snowsound Fiber 3 Melange sound-absorbing fabric. At the top and bottom, the structure is equipped with threaded bushings for fixing the tops and adjustable feet by means of special screws. The tops are made with a "sandwich" structure consisting of an MDF core enclosed between two aluminium plates, covered on the upper part and on the perimeter edges with brushed cement (handmade). The perimeter edge of the top is tapered. The artisanal nature of the workmanship of the tops makes each piece unique and exclusive.

Dimensions:

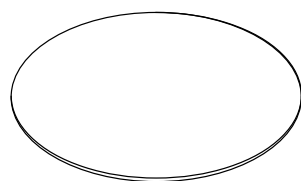
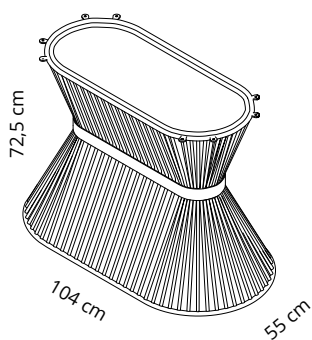
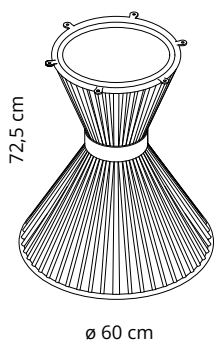

- ø 110 cm
- ø 120 cm
- ø 130 cm
- ø 140 cm

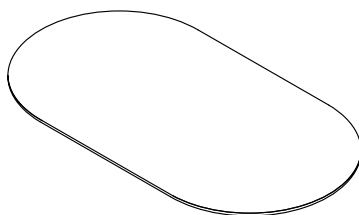

- |             |              |
|-------------|--------------|
| 90 x 160 cm | 100 x 160 cm |
| 90 x 180 cm | 100 x 180 cm |
| 90 x 200 cm | 100 x 200 cm |
| 90 x 220 cm | 100 x 220 cm |
| 90 x 240 cm | 100 x 240 cm |
| 90 x 260 cm | 100 x 260 cm |

- |              |              |
|--------------|--------------|
| 110 x 160 cm | 120 x 160 cm |
| 110 x 180 cm | 120 x 180 cm |
| 110 x 200 cm | 120 x 200 cm |
| 110 x 220 cm | 120 x 220 cm |
| 110 x 240 cm | 120 x 240 cm |
| 110 x 260 cm | 120 x 260 cm |

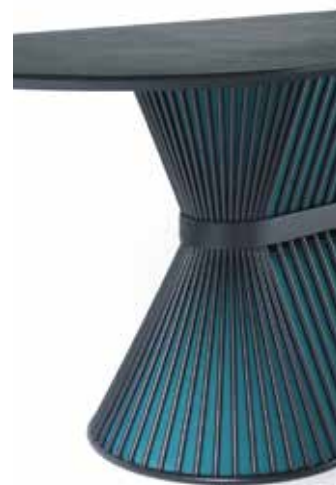

## ACOUSTIC PERFORMANCE

Measurement of sound absorption coefficient calculated according to ISO 354:2003, Frequency Hz / Aobj

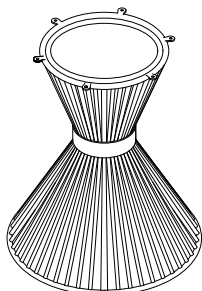

125 Hz / Aobj **0,42** m<sup>2</sup>  
250 Hz / Aobj **0,68** m<sup>2</sup>  
500 Hz / Aobj **0,94** m<sup>2</sup>  
1000 Hz / Aobj **0,96** m<sup>2</sup>  
2000 Hz / Aobj **0,88** m<sup>2</sup>  
4000 Hz / Aobj **0,82** m<sup>2</sup>

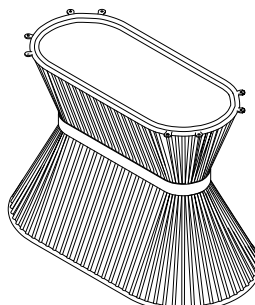

125 Hz / Aobj **0,92** m<sup>2</sup>  
250 Hz / Aobj **1,30** m<sup>2</sup>  
500 Hz / Aobj **1,61** m<sup>2</sup>  
1000 Hz / Aobj **1,65** m<sup>2</sup>  
2000 Hz / Aobj **1,51** m<sup>2</sup>  
4000 Hz / Aobj **1,47** m<sup>2</sup>

Available upholstery colours:

300



302



303



304



305



306



307



308



309



310



311



312



313

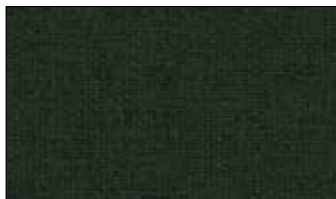

314



315



316

