

# ACOUSTIC ARTWORK

Technical information



# Quality and standards

ISO 11654

## 10 year Warranty

See Warranty statement

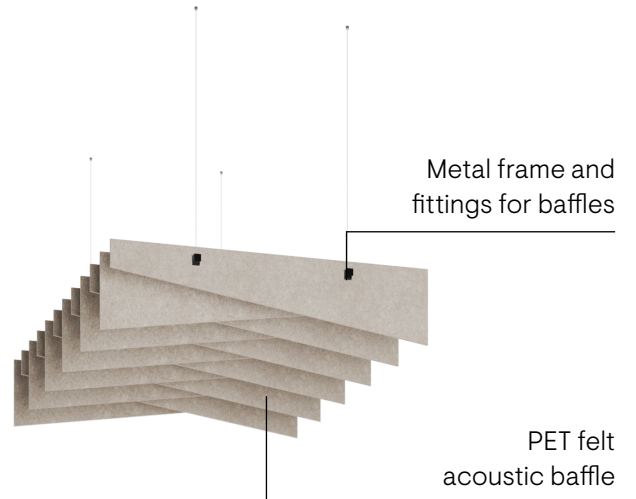
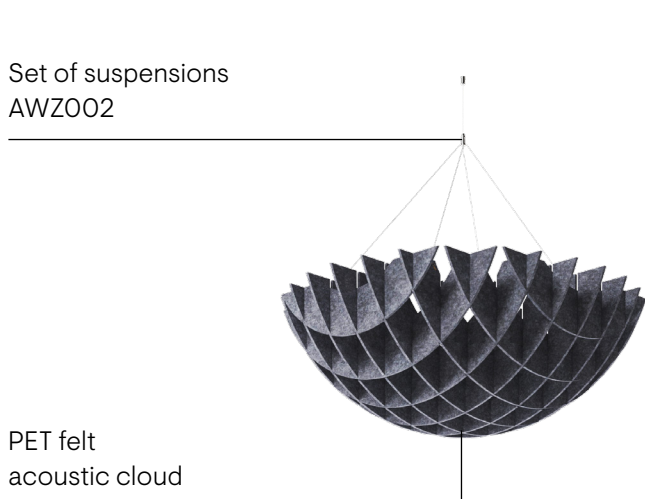
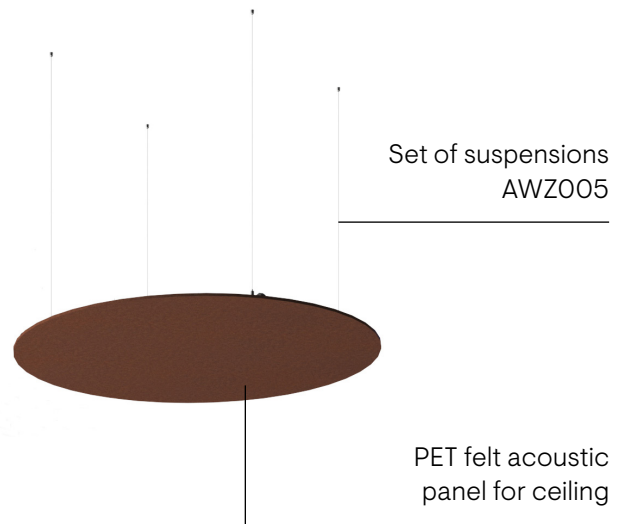

# Technical information

## Types

- ACOUSTIC ARTWORK Partitions (1)
- ACOUSTIC ARTWORK Ceiling (2)
- ACOUSTIC ARTWORK Wall (3)
- ACOUSTIC ARTWORK Accessories (4)

1



2

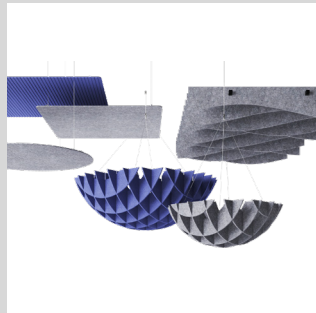

3

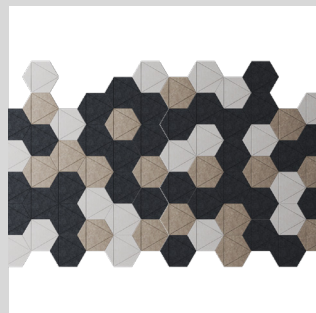

4



## ACOUSTIC ARTWORK Partitions

### Screen composition

- PET fiber board 9 mm.

### Set of suspensions AWZ001 (2 pcs.)

- Suitable only for PET partitions (up to 10 mm thick);
- Only a single product can be suspended per set;
- Set includes ceiling mounting (masonry/wood/gypsum);
- Adjustable cable gripper;
- Ø1,5 mm wire rope L-50-2000 mm.

### Set of suspensions AWZ004 (2 pcs.)

- Suitable only for PET partitions (up to 10 mm thick);
- Only a single product can be suspended per set;
- Set includes ceiling mounting (for T24 Armstrong profile);
- Adjustable cable gripper;
- Ø1,5 mm wire rope L-50-2000 mm.

## ACOUSTIC ARTWORK Ceiling

### Options

- PET felt acoustic cloud
- PET felt acoustic panel for ceiling
- PET felt acoustic baffle

### PET panel composition

- PET fiber board 9 mm.

### Set of suspensions AWZ002 (1 pc.), only for PET felt clouds

- Only a single product can be suspended per set;
- Set includes ceiling mounting (masonry/wood/gypsum);
- Ø1,5 mm wire rope L-50-2000 mm;
- Adjustable cable gripper;
- Two Ø1,5 mm wire ropes with metal plates L-1500 mm.

### Set of suspensions AWZ003 (1 pc.), only for PET felt clouds

- Suitable only for PET clouds;
- Only a single product can be suspended per set;
- Set includes ceiling mounting (for T24 Armstrong profile);

- Ø1,5 mm wire rope L-50-2000 mm;
- Adjustable cable gripper;
- Two Ø1,5 mm wire ropes with metal plates L-1500 mm.

### Set of suspensions AWZ005 (4 pcs.), only for ceiling PET acoustic panels

- Only a single product can be suspended per set;
- Set included ceiling mounting (masonry/wood/gypsum);
- Ø 1,2 mm wire rope L-50-3000 mm;
- Adjustable cable gripper.

### Metal frame and fittings for baffles

- Metal frame made of 20x20 mm metal tube;
- Powder-coated metal.

## ACOUSTIC ARTWORK Wall

### PET panel composition

- PET fiber board 9 mm.

### Adhesive for wall panels

- Must be bought separately;
- Virtually odourless;
- Non staining;
- Optimal application temperature +5°C until +35°C;
- Adhesive fittings for wall or ceiling (glass/wood/plastic/ceramics/varnished surfaces)\*.

## ACOUSTIC ARTWORK Accesories

### Options

- PET felt free-standing desk screen
- PET felt basket

### PET panel composition

- PET fiber board 9 mm.

\*The adhesive must flow onto the surface and create full surface contact. The surface to be bond must be free of grease, loose particles, and moisture.

# Range

## ACOUSTIC ARTWORK Partitions

PET felt acoustic partition pattern types

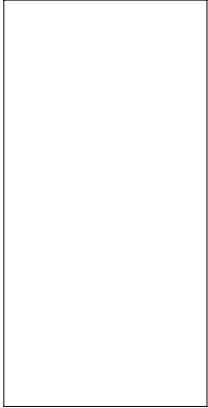

ZB0 PLAIN

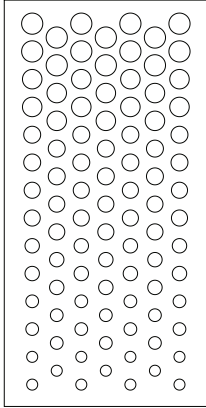

ZB1 DOT

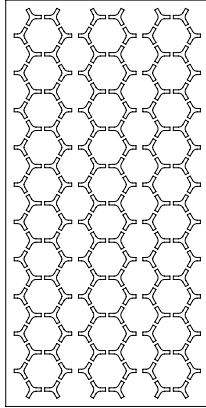

ZB2 HEX

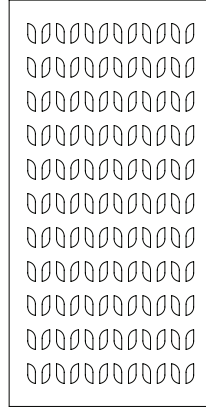

ZB3 FLOW

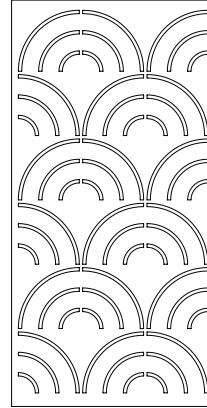

ZB4 DISCO

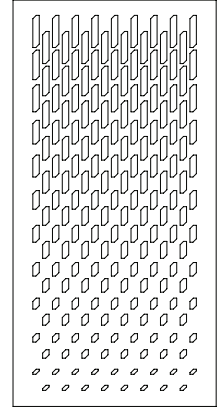

ZB5 GRATE

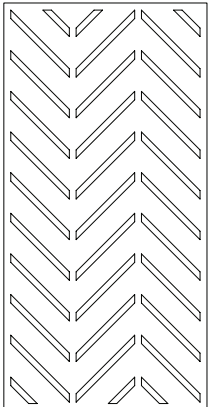

ZB6 CHEVRON

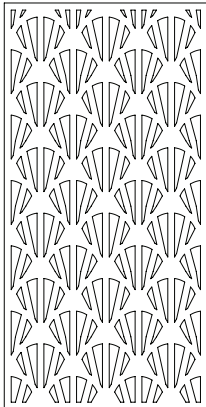

ZB7 CLAMS

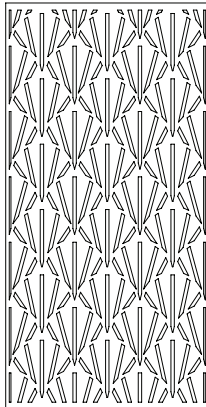

ZB8 REVERSE CLAMS

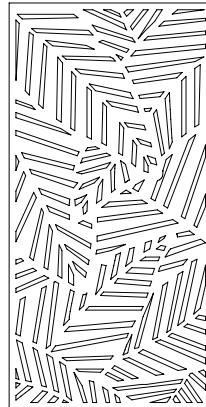

ZB9 PALMS

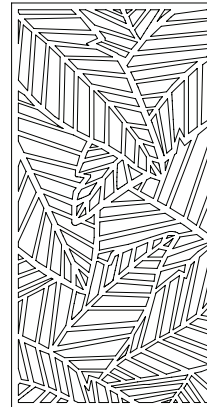

ZC1 REVERSE PALMS

### Sizes

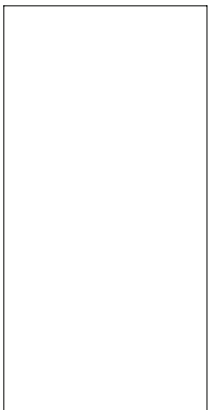

2000, 2400

800, 1200

# ACOUSTIC ARTWORK Wall

## PET felt tile pattern types

### Square



ZA0 PLAIN

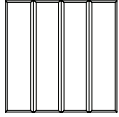

ZA3 STRAIGHT

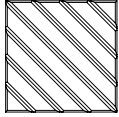

ZA4 DIAGONAL

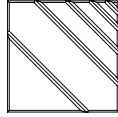

ZA7 SPACE  
DIAGONAL

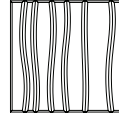

ZA8 LIANA

### Rectangle

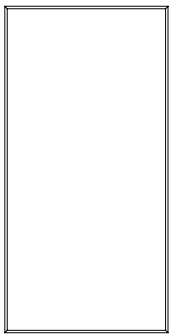

ZA0 PLAIN

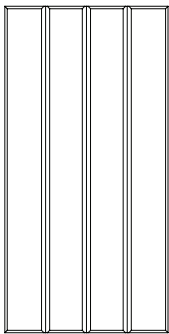

ZA3 STRAIGHT

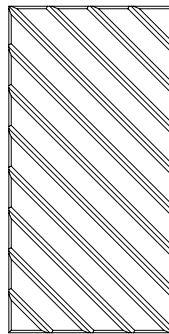

ZA4 DIAGONAL

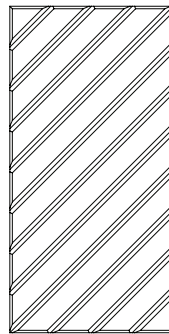

ZA5 DIAGONAL

### Triangle

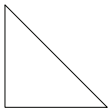

ZA0 PLAIN

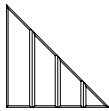

ZA3 STRAIGHT

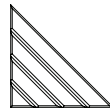

ZA4 DIAGONAL

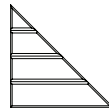

ZA6 STRAIGHT

### Hexagon

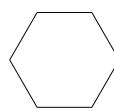

ZA0 PLAIN

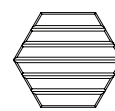

ZA3 STRAIGHT

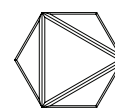

ZD3 TRIANGLE

### Diamond

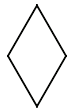

ZA0 PLAIN

## Sizes

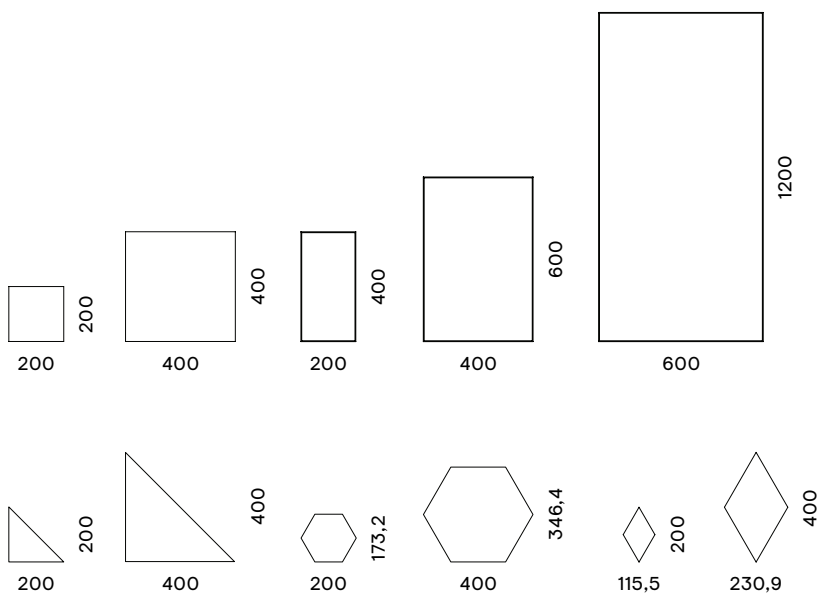

# ACOUSTIC ARTWORK Ceiling

PET felt acoustic cloud

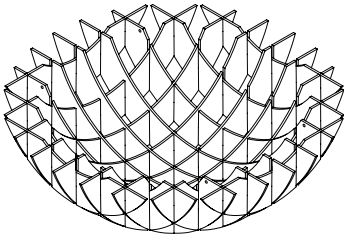

Sizes

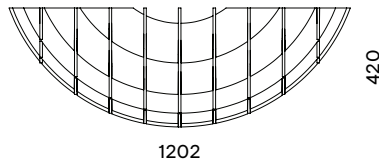
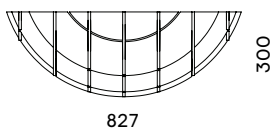

PET felt acoustic baffle types

Plain



Blade



Wave

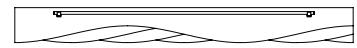

Sizes

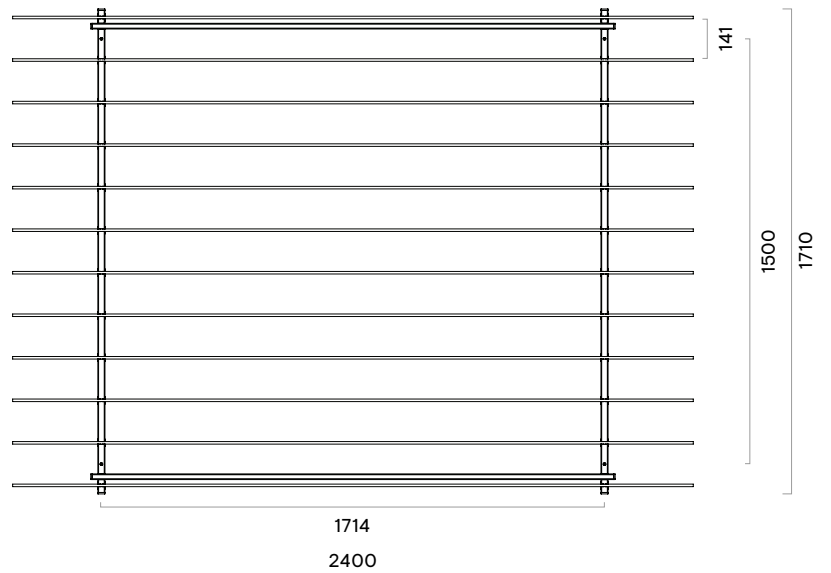
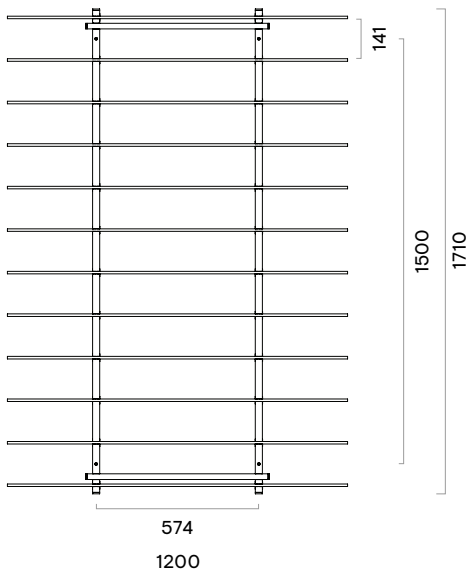

PET felt acoustic panel for ceiling pattern types

Square

Rectangle

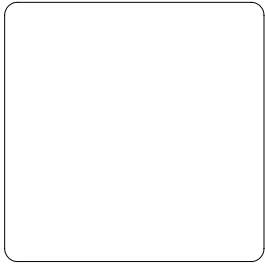

ZA0 PLAIN

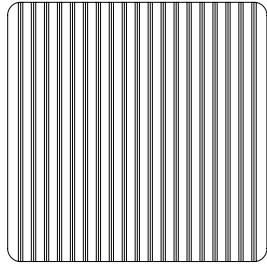

ZA3 STRAIGHT

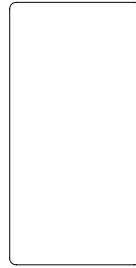

ZA0 PLAIN

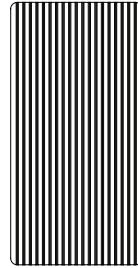

ZA3 STRAIGHT

Round

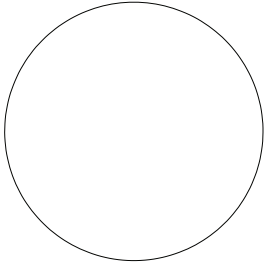

ZA0 PLAIN

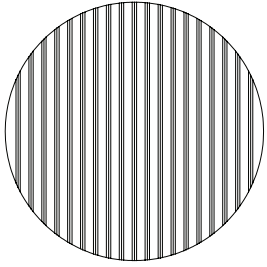

ZA3 STRAIGHT

Sizes

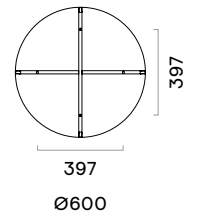
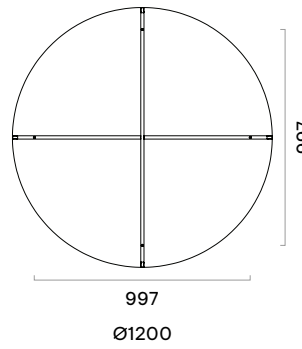
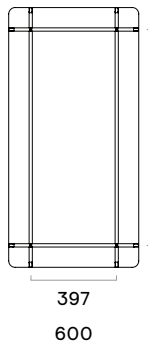
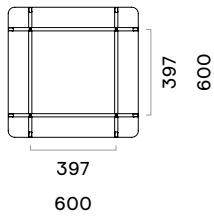
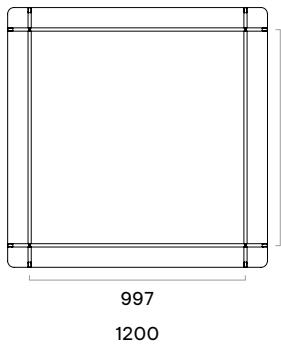

ACOUSTIC ARTWORK Accessories

PET felt free-standing desk screen

PET felt basket

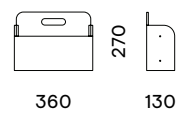
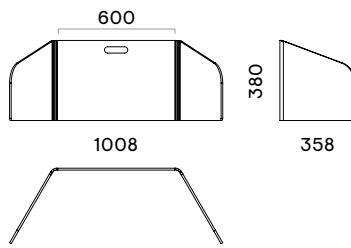
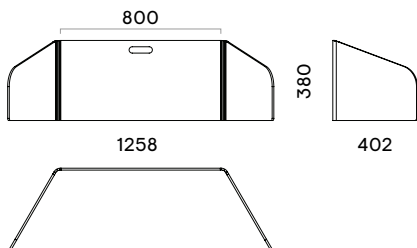



## Additional information

- Slight PET Felt color deviations can occur due to use of recycled material in the production of the product.
- Some undyed fibers may be present on the surface of the product.
- To ensure smooth and easy assembly PET partitions are delivered without holes for fittings. This is done in order to mitigate any problems which may hinder assembly such as placement of ducting, lighting or internal building constructions.

!

Only one way of PET Cloud suspension is allowed. Suspending product incorrectly may lead to product damage or people injury.

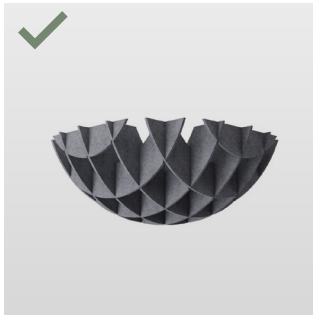

!

PET partition patterns were designed for vertical use. Although it is not forbidden to suspend this product horizontally, we cannot guarantee performance and aesthetic look of the partition.

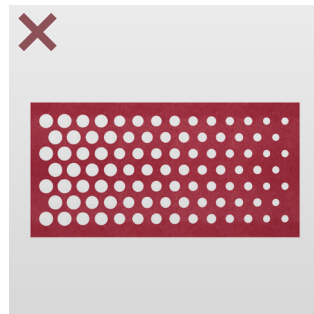
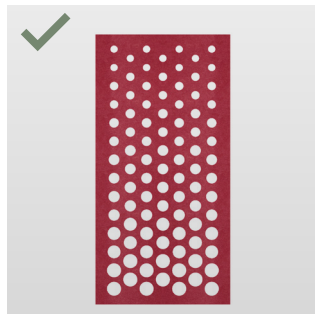
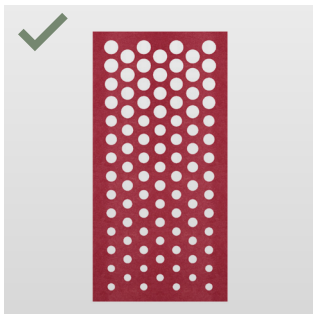

!

Please note that due to the size and shape of the PET Tiles not every Tile can be combined to create a uniform composition.



! \_\_\_\_\_  
Glueing example



## Adhesive consumption

Length of the product	Depth of the product	Area of the product, m <sup>2</sup>	The length of the adhesive strip around the perimeter and diagonally for the product, m	Consumption of glue bottles per product	Consumption of glue bottles, m <sup>2</sup>	Yield of glue bottle, m <sup>2</sup>
200	200	0,04	0,5	0,0	1,23	<b>1,9</b>
400	400	0,16	1,1	0,1	0,61	
200	400	0,08	0,6	0,1	0,70	
400	600	0,24	1,2	0,1	0,43	
600	1200	0,72	1,9	0,2	0,23	
200	200	0,04	0,5	0,0	1,23	
400	400	0,16	1,1	0,1	0,61	
173	200	0,03	0,5	0,0	1,25	
346	400	0,13	1,0	0,1	0,62	
762	334	0,25	1,9	0,2	0,69	
762	684	0,52	2,0	0,2	0,35	
762	1038	0,79	2,2	0,2	0,24	
762	1389	1,05	2,3	0,2	0,19	
962	334	0,32	2,4	0,2	0,68	
962	684	0,65	2,5	0,2	0,34	
962	1038	0,99	2,6	0,2	0,23	
962	1389	1,33	2,8	0,3	0,18	
1162	334	0,38	2,9	0,3	0,68	
1162	684	0,79	3,0	0,3	0,34	
1162	1038	1,20	3,1	0,3	0,23	
573	1389	0,79	1,9	0,2	0,21	
1562	334	0,52	3,9	0,4	0,68	
1562	684	1,06	4,0	0,4	0,33	
772	1038	0,80	2,2	0,2	0,24	
772	1389	1,07	2,3	0,2	0,19	