

OMNIA

HIGH BACK MESH CHAIR



Code OOMNIA03

DESCRIPTION

High back task armchair with mesh backrest

NOTE

65mm wheel brake in hard, soft or ring - Height adjustable lumbar support

SPECIFICATIONS

STRUCTURE

Backrest in nylon. Internal chair structure in beech plywood.

MECHANISM

MEC14 - Synchron self-adjusting with self-adjustment tilt tension - Anti-shock device - 5 positons

MEC04 - Synchron - Anti-shock device - 5 positons - Lateral weight adjustment

MEC05 - Synchron - Anti-shock device - 5 positons - Lateral weight adjustment - Seat depth control (slide)

PADDING INJECTION MOLDED POLYURETHANE FOAM PADDING

Seat: thickness 50 mm, density 50 Kg/m³

ARMS (OPTIONAL)

Fixed - nylon

Height adjustable- nylon, polyurethane soft-touch pad

2D multi-adjustable (Height, top movable) - nylon, polyurethane soft-touch pad

3D multi-adjustable (height - top movable and swivel) - nylon, polyurethane soft-touch pad

LEGS / FRAME / BASE

Nylon 700mm or Aluminum 700mm

UPHOLSTERY

Backrest - 100% polyester R06 mesh

Seat - categories B01-B03-C01-C05-D02-D05-D06-E01-P01

SIZE

Dimensions in millimeters

chair

L 700 H 1030-1150 D 700

seat

L 500 H 420-550 D 470

backrest

L 450 H 580

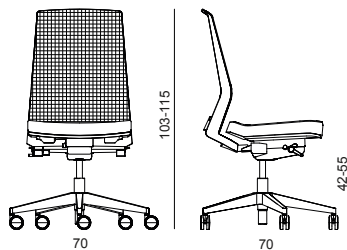

WEIGHT

Net weight a chair: 15,5 Kg

Gross weight a chair: 17,5 Kg

PACKAGING

1 x package

L 710 H 650 D 480

VOLUME

M3 a chair: 0,22

OMNIA

HIGH BACK MESH CHAIR WITH HEADREST

Code OOMNIP03



DESCRIPTION

High back task armchair with mesh backrest and headrest

NOTE

65mm wheel brake in hard, soft or ring - Height adjustable lumbar support

SPECIFICATIONS

STRUCTURE

Backrest in nylon. Internal chair structure in beech plywood.

MECHANISM

MEC14 - Synchron self-adjusting with self-adjustment tilt tension - Anti-shock device - 5 positions

MEC04 - Synchron - Anti-shock device - 5 positions - Lateral weight adjustment

MEC05 - Synchron - Anti-shock device - 5 positions - Lateral weight adjustment - Seat depth control (slide)

PADDING INJECTION MOLDED POLYURETHANE FOAM PADDING

Seat: thickness 50 mm, density 50 Kg/m³

ARMS (OPTIONAL)

Fixed - nylon

Height adjustable- nylon, polyurethane soft-touch pad

2D multi-adjustable (Height, top movable) - nylon, polyurethane soft-touch pad

3D multi-adjustable (height - top movable and swivel) - nylon, polyurethane soft-touch pad

LEGS / FRAME / BASE

Nylon 700mm or Aluminum 700mm

UPHOLSTERY

Backrest - 100% polyester R06 mesh

Seat - categories B01-B03-C01-C05-D02-D05-D06-E01-P01

SIZE

Dimensions in millimeters

chair

L 700 H 1140-1260 D 700

seat

L 500 H 420-550 D 470

backrest

L 450 H 580

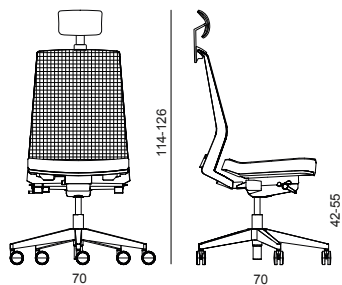

WEIGHT

Net weight a chair: 16,0 Kg

Gross weight a chair: 18,0 Kg

PACKAGING

1 x package

L 710 H 650 D 480

VOLUME

M3 a chair: 0,22

OMNIA

HIGH BACK CHAIR

CATAS UNI EN 1335 B, UNI EN 1728  UNI EN 9083, UNI EN 9084

Code OOMNIA01



DESCRIPTION

High back ergonomic task armchair

NOTE

65mm wheel brake in hard, soft or ring - Height adjustable backrest - Height adjustable lumbar support
1IM fire retardant B01, B03, P01 fabric upholstered shell 

SPECIFICATIONS

STRUCTURE

Backrest in polypropylene. Internal chair structure in beech plywood.

MECHANISM

MEC14 - Synchron self-adjusting with self-adjustment tilt tension - Anti-shock device - 5 positions
MEC04 - Synchron - Anti-shock device - 5 positions - Lateral weight adjustment
MEC05 - Synchron - Anti-shock device - 5 positions - Lateral weight adjustment - Seat depth control (slide)

PADDING INJECTION MOLDED POLYURETHANE FOAM PADDING

Seat: thickness 50 mm, density 50 Kg/m³
Backrest: thickness 40 mm, density 50 Kg/m³

ARMS

Fixed - nylon
Height adjustable- nylon, polyurethane soft-touch pad
2D multi-adjustable (Height, top movable) - nylon, polyurethane soft-touch pad
3D multi-adjustable (height - top movable and swivel) - nylon, polyurethane soft-touch pad

LEGS / FRAME / BASE

Nylon 700mm or Aluminum 700mm

UPHOLSTERY

categories B01-B03-C01-C05-D02-D05-D06-E01-P01

SIZE

Dimensions in millimeters

chair
L 700 H 1030-1210 D 700

seat
L 500 H 420-550 D 470

backrest
L 470 H 610-670

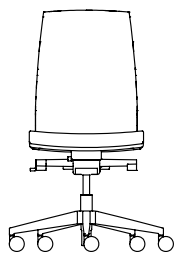

74

103-121

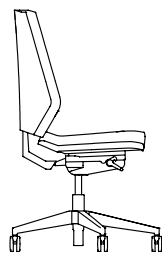

74

42-54

WEIGHT

Net weight a chair: 16 Kg
Gross weight a chair: 18 Kg

PACKAGING

1 x package
L 710 H 650 D 480

VOLUME

M3 a chair: 0,22

OMNIA

MID BACK CHAIR

CATAS UNI EN 1335 B, UNI EN 1728  UNI EN 9083, UNI EN 9084

Code OOMNIB01



DESCRIPTION

Mid back ergonomic task armchair

NOTE

65mm wheel brake in hard, soft or ring - Height adjustable backrest - Height adjustable lumbar support
1M fire retardant B01, B03, P01 fabric upholstered shell 

SPECIFICATIONS

STRUCTURE

Backrest in polypropylene. Internal chair structure in beech plywood.

MECHANISM

MEC14 - Synchron self-adjusting with self-adjustment tilt tension - Anti-shock device - 5 positions
MEC04 - Synchron - Anti-shock device - 5 positions - Lateral weight adjustment
MEC05 - Synchron - Anti-shock device - 5 positions - Lateral weight adjustment - Seat depth control (slide)

PADDING INJECTION MOLDED POLYURETHANE FOAM PADDING

Seat: thickness 50 mm, density 50 Kg/m³
Backrest: thickness 40 mm, density 50 Kg/m³

ARMS

Fixed - nylon
Height adjustable- nylon, polyurethane soft-touch pad
2D multi-adjustable (Height, top movable) - nylon, polyurethane soft-touch pad
3D multi-adjustable (height - top movable and swivel) - nylon, polyurethane soft-touch pad

LEGS / FRAME / BASE

Nylon 700mm or Aluminum 700mm

UPHOLSTERY

Seat - categories B01-B03-C01-C05-D02-D05-D06-E01-P01

SIZE

Dimensions in millimeters

chair
L 700 H 910-1140 D 700

seat
L 500 H 420-550 D 470

backrest
L 470 H 470-530

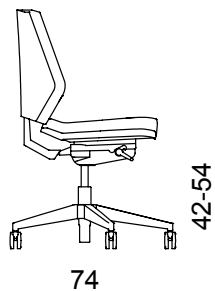
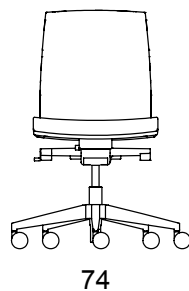

WEIGHT

Net weight a chair: 16 Kg
Gross weight a chair: 18 Kg

PACKAGING

1 x package
L 710 H 650 D 480

VOLUME

M3 a chair: 0,22

OMNIA

OMNIA WITH HEADREST

CATAS UNI EN 1335 B, UNI EN 1728  UNI EN 9083, UNI EN 9084

Code OOMNIP01



DESCRIPTION

High back ergonomic task armchair with headrest

NOTE

65mm wheel brake in hard, soft or ring - Height adjustable backrest - Height adjustable lumbar support - Height adjustable and reclining padded headrest.

1IM fire retardant B01, B03, P01 fabric upholstered shell 

SPECIFICATIONS

STRUCTURE

Backrest in polypropylene. Internal chair structure in beech plywood.

MECHANISM

MEC14 - Synchron self-adjusting with self-adjustment tilt tension - Anti-shock device - 5 positions

MEC04 - Synchron - Anti-shock device - 5 positions - Lateral weight adjustment

MEC05 - Synchron - Anti-shock device - 5 positions - Lateral weight adjustment - Seat depth control (slide)

PADDING INJECTION MOLDED POLYURETHANE FOAM PADDING

Seat: thickness 50 mm, density 50 Kg/m³

Backrest: thickness 40 mm, density 50 Kg/m³

ARMS

Fixed - nylon

Height adjustable- nylon, polyurethane soft-touch pad 2D multi-adjustable (Height, top movable) - nylon, polyurethane soft-touch pad

3D multi-adjustable (height - top movable and swivel) - nylon, polyurethane soft-touch pad

LEGS / FRAME / BASE

Nylon 700mm or Aluminum 700mm

UPHOLSTERY

Seat - categories B01-B03-C01-C05-D02-D05-D06-E01-P01

SIZE

Dimensions in millimeters

chair

L 700 H 1190-1320 D 700

seat

L 500 H 420-550 D 470

backrest

L 470 H 610-670 +200

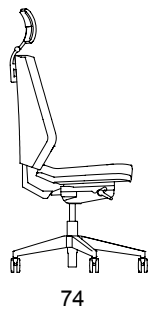
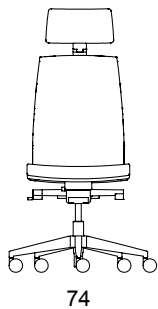

WEIGHT

Net weight a chair: 16,5 Kg

Gross weight a chair: 18,5 Kg

PACKAGING

1 x package

L 710 H 650 P 480

VOLUME

M3 a chair: 0,22

OMNIA

VISITOR CHAIR



Code OOMNIV01

DESCRIPTION
Visitor armchair

SPECIFICATIONS

STRUCTURE

Backrest in polypropylene. Internal chair structure in beech plywood.

PADDING INJECTION MOLDED POLYURETHANE FOAM PADDING

Seat: thickness 50 mm, density 50 Kg/m³

Backrest: thickness 40 mm, density 50 Kg/m³

ARMS (OPTIONAL)

Fixed - nylon

Height adjustable- nylon, polyurethane soft-touch pad
2D multi-adjustable (Height, top movable) - nylon, polyurethane soft-touch pad

3D multi-adjustable (height - top movable and swivel) - nylon, polyurethane soft-touch pad

LEGS / FRAME / BASE

Black painted rectangular tubes 30×15×2,5

UPHOLSTERY

Seat - categories B01-B03-C01-C05-D02-D05-D06-E01-P01

SIZE

Dimensions in millimeters

chair
L 500 H 1000 D 600

seat
L 500 H 440 D 470

backrest
L 470 H 470

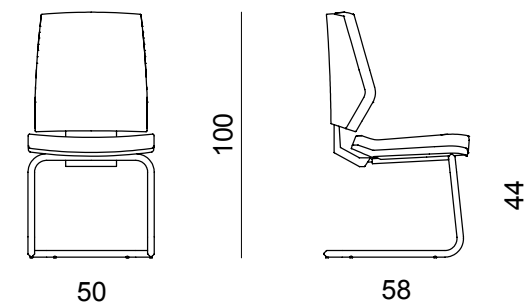

WEIGHT

Net weight a chair: 17 Kg

Gross weight a chair: 19 Kg

PACKAGING

1 x package

L 680 H 530 D 525

VOLUME

M3 a chair: 0,19