

**SNOWSOUND**

Acoustics & Wellbeing technologies

**Caimi**

**vicini alle persone**  
**vicini al futuro**

**close to people**  
**close to the future**

# **Snowsound**

Acoustics & Wellbeing technologies



Clicca e vai alla pagina selezionata.

Click and go to the selected page.

|            |   |
|------------|---|
| <b>12</b>  | <b>COMPANY PROFILE</b>                      |
| <b>18</b>  | <b>WELLBEING TECHNOLOGIES</b>               |
| <b>26</b>  | <b>SNOWSOUND SOFTWARE</b>                   |
| <b>32</b>  | <b>SUSTAINABILITY</b>                       |
| <b>36</b>  | <b>PRODUCTS: SNOWCURTAINS (CUSTOM MADE)</b> |
| <b>48</b>  | <b>SNOWSOUND FIBER</b>                      |
| <b>60</b>  | <b>SNOWSOUND PRODUCTS</b>                   |
| <b>258</b> | <b>WALL COVERINGS</b>                       |
| <b>270</b> | <b>SNOWSOUND SOFAS &amp; TABLES</b>         |
| <b>302</b> | <b>SNOWSOUND ART</b>                        |
| <b>314</b> | <b>PROJECTS</b>                             |
| <b>336</b> | <b>SNOWSOUND FIBER TEXTILES</b>             |
| <b>338</b> | <b>SNOWSOUND TECHNOLOGY</b>                 |
| <b>340</b> | <b>SNOWCUSTOM TECHNOLOGY</b>                |
| <b>342</b> | <b>PRODUCTS DIMENSIONS &amp; COLOURS</b>    |

# PRODUCTS INDEX

## LEGENDA / SYMBOLS



Tende manuali a strappo.  
Manual curtain systems.



Tende a rullo.  
Roller shades.



Divani e tavoli acustici.  
Acoustic sofas and tables.



Applicazione a parete.  
Wall application.



Applicazione a soffitto.  
Ceiling application.



Applicazione a baffle/soffitto.  
Baffle/ceiling application.



Applicazione free-standing.  
Free-standing application.



Applicazione a scrivania.  
Desk application.



Applicazione con illuminazione.  
Lighting application.



Prodotto con marcatura CE.  
Product with CE marking.

|     |                         |     |                          |     |  |
|-----|-------------------------|-----|--------------------------|-----|--|
| 198 | <b>BAFFLE</b>           | 296 | <b>FULCRO</b>            | 260 | <b>SNOWALL</b>                           |
| 204 | <b>BAFFLE DIRECT</b>    | 152 | <b>GIOTTO</b>            | 266 | <b>SNOWALL MAXI</b>                      |
| 202 | <b>BAFFLE OVERSIZE</b>  | 156 | <b>GIOTTO LUX</b>        | 36  | <b>SNOWCURTAINS (CUSTOM MADE)</b>        |
| 246 | <b>BEMOLLE</b>          | 216 | <b>IN</b>                | 74  | <b>SNOWCUSTOM</b>                        |
| 244 | <b>BLADE</b>            | 254 | <b>INDUSTRIAL</b>        | 130 | <b>SNOWFIX   SNOWMAGNET</b>              |
| 100 | <b>BOTANICA</b>         | 62  | <b>INTEGRAL</b>          | 240 | <b>SNOWFRONT</b>                         |
| 94  | <b>BOW</b>              | 172 | <b>KLIPPER</b>           | 88  | <b>SNOWGEMS</b>                          |
| 284 | <b>CILINDRO</b>         | 298 | <b>LUCREZIO</b>          | 280 | <b>SNOWKING</b>                          |
| 110 | <b>CLASP DIVIDER</b>    | 218 | <b>MIA</b>               | 290 | <b>SNOWPOUF</b>                          |
| 106 | <b>CLASP RING</b>       | 68  | <b>MILANO</b>            | 288 | <b>SNOWSOFA</b>                          |
| 80  | <b>CLIMBING</b>         | 230 | <b>MINIMAL</b>           | 312 | <b>SNOWSOUND ART, Sezgin Aksu</b>        |
| 252 | <b>COCKER</b>           | 220 | <b>MITESCO</b>           | 306 | <b>SNOWSOUND ART, Gillo Dorfles</b>      |
| 234 | <b>CORNER</b>           | 272 | <b>NAPWORK</b>           | 308 | <b>SNOWSOUND ART, Alessandro Mendini</b> |
| 57  | <b>FIBER 1 Color</b>    | 170 | <b>OBELISCO</b>          | 304 | <b>SNOWSOUND ART, Gio Ponti</b>          |
| 52  | <b>FIBER 2 Line</b>     | 242 | <b>OVERSIZE DESK</b>     | 310 | <b>SNOWSOUND ART, Mario Trimarchi</b>    |
| 53  | <b>FIBER 2R Line-R</b>  | 142 | <b>OVERSIZE LUX</b>      | 136 | <b>SNOWSOUND CEILING</b>                 |
| 55  | <b>FIBER 3 Melange</b>  | 214 | <b>PAGODA</b>            | 160 | <b>SURF</b>                              |
| 56  | <b>FIBER 6 Velvet</b>   | 248 | <b>PINNA</b>             | 148 | <b>TELETA</b>                            |
| 50  | <b>FIBER 7 Velo</b>     | 126 | <b>PLI</b>               | 166 | <b>TL   TL LUX</b>                       |
| 54  | <b>FIBER 8 Bouclé</b>   | 238 | <b>PLI DESK</b>          | 212 | <b>TRA</b>                               |
| 58  | <b>FIBER 12 Econyl®</b> | 118 | <b>PLI OVER</b>          | 208 | <b>TRA LIGHT</b>                         |
| 186 | <b>FLAP</b>             | 122 | <b>PLI OVERSIZE</b>      | 84  | <b>TRI BU</b>                            |
| 176 | <b>FLAT</b>             | 114 | <b>SEPÀ   SEPÀ ROLLS</b> | 276 | <b>VOLUMI</b>                            |
| 182 | <b>FLOAT</b>            | 250 | <b>SI SBOCCIA</b>        |     |  |

# CEILING PRODUCTS



Clicca e vai alla pagina selezionata.  
Click and go to the selected page.



Clicca e vai alla pagina selezionata.  
Click and go to the selected page.



**INTEGRAL**  
Bartoli Design **64**



**SURF**  
Caimi Lab **160**



**MILANO**  
Caimi Lab **68**



**SNOWSOUND CEILING**  
Caimi Lab **136**

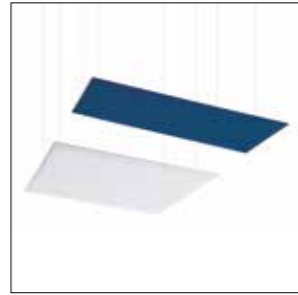

**SNOWSOUND CEILING**  
Caimi Lab **139**



**SNOWSOUND CEILING**  
Caimi Lab **138**



**FLAP**  
Alberto Meda  
Francesco Meda **188**

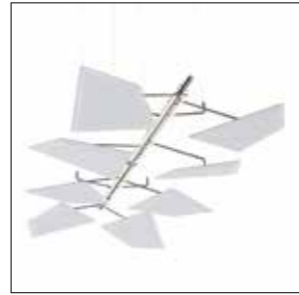

**FLAP CEILING**  
Alberto Meda  
Francesco Meda **190**



**V-FLAP**  
Alberto Meda  
Francesco Meda **196**



**MITESCO CEILING**  
Michele De Lucchi **223**



**BOW**  
King & Miranda **99**



**CLASP RING**  
(a+b) Annalisa Dominoni  
Benedetto Quaquaro **106**



**BAFFLE**  
Marc Sadler **198**



**BAFFLE OVERSIZE**  
Marc Sadler **202**



**BAFFLE DIRECT**  
Marc Sadler **204**



**FLAT**  
Alberto Meda  
Francesco Meda **178**

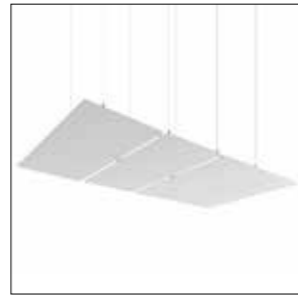

**FLOAT**  
Alberto Meda  
Francesco Meda **182**

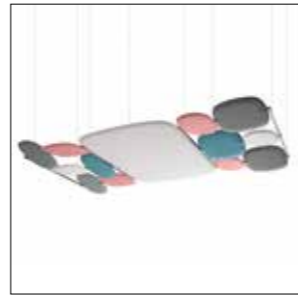

**SNOWGEMS**  
(a+b) Annalisa Dominoni  
Benedetto Quaquaro **93**



**IN**  
Caimi Lab **216**



**PAGODA**  
Caimi Lab **214**



**SI SBOCCIA CEILING**  
Moreno Ferrari **250**



**PINNA**  
(a+b) Annalisa Dominoni  
Benedetto Quaquaro **248**



**INDUSTRIAL**  
Caimi Lab **254**



**SNOWCUSTOM**  
Caimi Lab **78**



**BOTANICA CEILING**  
Mario Trimarchi **100**



**BOTANICA**  
Mario Trimarchi **104**



**GIOTTO**  
Sezgin Aksu **152**



**TL**  
design by Gio Ponti **166**



**TRA**  
Marc Sadler **212**



**TRA LIGHT**  
Marc Sadler **208**

## WALL PRODUCTS



Clicca e vai alla pagina selezionata.  
Click and go to the selected page.

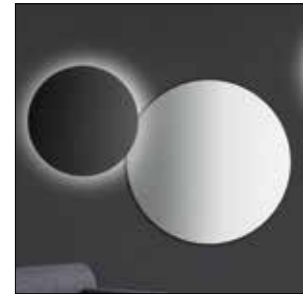

**INTEGRAL**  
Bartoli Design **62**



**SURF**  
Caimi Lab **165**



**SNOWALL**  
Caimi Lab **260**

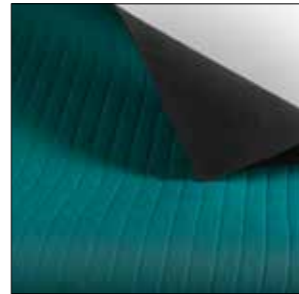

**SNOWALL MAXI**  
Caimi Lab **266**



**CLIMBING**  
Raffaello Manzoni **80**



**TRI BU**  
Paola Navone  
Otto Studio **84**



**MITESCO**  
Michele De Lucchi **220**



**FLAP**  
Alberto Meda  
Francesco Meda **186**



**SI SBOCCIA**  
Moreno Ferrari **250**

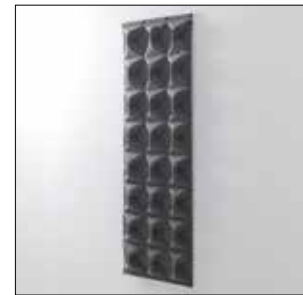

**KLIPPER**  
Felicia Arvid **172**



**BOW**  
King & Miranda **94**



**SNOWGEMS**  
(a+b) Annalisa Dominoni  
Benedetto Quaquaro **92**

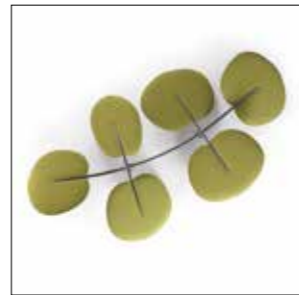

**BOTANICA WALL**  
Mario Trimarchi **103**



**BOTANICA**  
Mario Trimarchi **104**



**MIA**  
Marta Martino **218**



**PINNA**  
(a+b) Annalisa Dominoni  
Benedetto Quaquaro **248**



**BLADE**  
Lorenzo Damiani **244**



**COCKER**  
Caimi Lab **252**



**FLAT**  
Alberto Meda  
Francesco Meda **176**



**SNOWFIX**  
Caimi Lab **130**



**SNOWMAGNET**  
Caimi Lab **130**



**GIOTTO WALL**  
Sezgin Aksu **154**



**SNOWCUSTOM**  
Caimi Lab **74**



**INDUSTRIAL**  
Caimi Lab **254**



**BEMOLLE**  
Atelier Medinii **246**

Clicca e vai alla pagina selezionata.  
Click and go to the selected page.

## SNOWSOUND ART



**GIO PONTI**  
The splendor of future **304**



**ALESSANDRO MENDINI**  
Ideas, things **308**



**GILLO DORFLES**  
Enormous design **306**



**MARIO TRIMARCHI**  
Silence **310**



**SEZGIN AKSU**  
Design clues **312**

## DESK & DIVIDER PRODUCTS

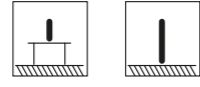

**CORNER**  
Marc Sadler **234**



**MINIMAL**  
Caimi Lab **230**



**MITESCO DESK**  
Michele De Lucchi **228**

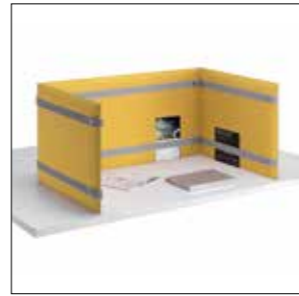

**PLI DESK**  
Marc Sadler **238**



**SNOWFRONT**  
Caimi Lab **240**



**OVERSIZE DESK**  
Caimi Lab **242**



**PLI**  
Marc Sadler **126**



**PLI OVERSIZE**  
Marc Sadler **122**



**PLI OVER**  
Marc Sadler **118**



**SNOWGEMS**  
(a+b) Annalisa Dominoni  
Benedetto Quaquaro **88**



**SEPÀ**  
Sezgin Aksu **114**



**SEPÀ ROLLS**  
Sezgin Aksu **114**



**MITESCO DIVIDER**  
Mitesco De Lucchi **224**



**TRA LIGHT**  
Marc Sadler **208**



**CLASP DIVIDER**  
(a+b) Annalisa Dominoni  
Benedetto Quaquaro **110**



Clicca e vai alla pagina selezionata.  
Click and go to the selected page.

## TOTEM PRODUCTS



**SNOWGEMS**  
(a+b) Annalisa Dominoni  
Benedetto Quaquaro **91**



**BOTANICA TOTEM**  
Mario Trimarchi **105**



**FLAT TOTEM**  
Alberto Meda  
Francesco Meda **181**



**FLAP TOTEM**  
Alberto Meda  
Francesco Meda **194**



**MITESCO TOTEM**  
Michele De Lucchi **226**



**OBELISCO**  
design By Gio Ponti **170**

## LIGHTING SYSTEMS



**OVERSIZE LUX**  
Marc Sadler **142**



**MILANO**  
Caimi Lab **68**



**INTEGRAL**  
Bartoli Design **62**



**SURF**  
Caimi Lab **160**



**CLASP RING**  
(a+b) Annalisa Dominoni  
Benedetto Quaquaro **106**



**FLAP CEILING LUX**  
Alberto Meda  
Francesco Meda **192**

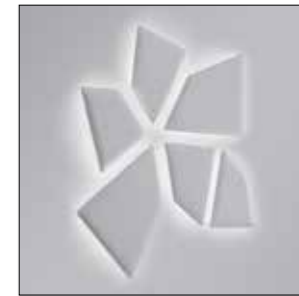

**FLAP LUX**  
Alberto Meda  
Francesco Meda **193**



**GIOTTO LUX**  
Sezgin Aksu **156**



**TL LUX**  
design by Gio Ponti **166**



**FLAT LUX**  
Alberto Meda  
Francesco Meda **180**



**TELETA**  
Alessandro Zambelli **148**



Clicca e vai alla pagina selezionata.  
Click and go to the selected page.

## SNOWSOUND SOFAS & TABLES



Clicca e vai alla pagina selezionata.  
Click and go to the selected page.



**NAPWORK** 272  
Paola Navone  
Otto Studio



**SNOWKING** 280  
(a+b) Annalisa Dominoni  
Benedetto Quaquaro



**CILINDRO** 284  
Claudio Bellini



**VOLUMI** 276  
Caimi Lab



**SNOWSOFA** 288  
Sezgin Aksu



**LUCREZIO** 298  
Caimi Lab



**SNOWPOUF** 290  
Paola Navone  
Otto Studio



**FULCRO** 296  
Claudio Bellini

## FABRICS & CUSTOM MADE CURTAINS

Clicca e vai alla pagina selezionata.  
Click and go to the selected page.



**FIBER 1 Color** 57



**FIBER 2 Line** 52



**FIBER 2R Line-R** 53

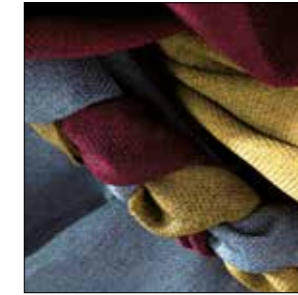

**FIBER 3 Melange** 55



**FIBER 6 Velvet** 56



**FIBER 7 Velo** 50



**FIBER 8 Bouclé** 54



**FIBER 12 Econyl®** 58



**SNOWCURTAINS DRAPERY** 38



**SNOWCURTAINS ROLLER SHADES** 44



# CAIMI BREVETTI

## Made in Italy since 1949

**I**\_Fondata nel 1949, Caimi è una delle principali realtà produttive europee design oriented nel settore dell'arredamento, dei complementi d'arredo e delle soluzioni acustiche per l'ufficio, la casa e il contract. Da **75 anni** Caimi continua a ricercare e sperimentare nuove soluzioni per migliorare concretamente la vita delle persone e gli ambienti in cui vivono. Grazie ad una sofisticata integrazione fra struttura produttiva e logistica, gestisce con successo una gamma di prodotti composta da oltre **3.500** articoli e **35.000** componenti, garantendo alla propria clientela tempi di consegna estremamente rapidi.

**EN**\_Founded in 1949, Caimi is one of the leading European design-oriented manufacturers of furniture and complements for the office, home and contract sectors. For **75 years** Caimi has continued to research and assay new solutions for the betterment of people's lives and living spaces. Thanks to its sophisticated integration of production line work and logistics operations, Caimi can effect extremely fast deliveries of any orders from its product range, which is made up of around **3.500** items and more than **35.000** separate components.

**F**\_Fondée en 1949, Caimi est l'une des principales entreprises européennes de production axée sur le design, dans le domaine de l'ameublement, des accessoires de décoration et des solutions acoustiques pour le bureau, la maison et les grands projets clé en main. Depuis **75 années**, Caimi est à la recherche de nouvelles solutions pour améliorer de manière concrète la vie des personnes et de leur habitat. Grâce à une intégration sophistiquée entre sa structure de production et la logistique, Caimi peut gérer avec succès une gamme d'environ **3.500** produits avec plus de **35.000** composants, assurant ainsi des délais de livraison extrêmement rapides à ses clients.

**D**\_1949 gegründet, ist Caimi eines der führenden Design-orientierten Hersteller in Europa in der Branche Einrichtung, Einrichtungszubehör und Schalldämpflösungen für Büro, Wohnen und Contract. Seit **75 Jahren** erforscht und experimentiert Caimi neue Lösungen, um das Leben der Menschen und die Räume, in denen sie leben, zu verbessern. Dank der hochentwickelten Integration zwischen Produktion und Logistik kann Caimi eine breite Palette an Produkten erfolgreich herstellen und vertreiben, die über **3.500** Produkte und **35.000** Komponenten miteinschließt, und somit den eigenen Kunden extrem schnelle Lieferzeiten garantieren.

**E**\_Fundada en 1949, Caimi es una de las principales empresas productoras europeas dedicada al diseño en el sector del interiorismo, de los complementos decorativos y de las soluciones acústicas para oficina, hogar y contract. Desde hace **75 años**, Caimi investiga y desarrolla, de forma continua, novedosas soluciones para mejorar el bienestar de las personas y el entorno en el que viven. Gracias a una integración avanzada entre estructura de producción y logística, gestiona exitosamente una gama de productos que consta de más de **3.500** artículos y **35.000** componentes, garantizando a sus clientes plazos de entrega sumamente rápidos.



# AWARDS

## Over 70 international awards

**I**\_Presente nei musei di design internazionali, Caimi ha ricevuto decine di riconoscimenti e premi in tutto il mondo, tra i quali tre Compassi d'Oro, tre German Design Award, e diciannove ADI design Index. Nel 2020 quattro opere sono entrate a far parte della collezione permanente di Arte e Design del Quirinale (Residenza del Presidente della Repubblica Italiana): due pannelli SNOWSOUND ART, disegnati da Gillo Dorfles, e due composizioni BOTANICA, design Mario Trimarchi.

**EN**\_With its products displayed in design museums around the world, Caimi has received dozens of international awards and prizes, including three Compasso d'Oro prizes, three German Design Award, and nineteen ADI Design Index prizes. In 2020, four CAIMI designs were added to the permanent Art and Design collection at the Italian President's official residence in Rome, the Quirinale Palace. Specifically, two SNOWSOUND ART panels designed by Gillo Dorfles and two BOTANICA compositions designed by Mario Trimarchi.

**F**\_Présente dans les musées internationaux de design, Caimi a reçu des dizaines de prix et récompenses dans le monde entier, dont trois Compasso d'Oro, trois German Design Award et dix-neuf ADI design Index. En 2020 quatre œuvres ont été admises dans la collection permanente Art et Design du Quirinal (la résidence du Président de la République italienne) : deux panneaux SNOWSOUND ART, conçus par Gillo Dorfles, et deux compositions BOTANICA, conçus par Mario Trimarchi.

**D**\_In den internationale Design-Museen ausgestellt, wurde Caimi mit zahlreichen Preisen und Auszeichnungen in der ganzen Welt bedacht, darunter drei Compasso d'Oro, drei German Design Award und neunzehn ADI Design Index. Die vollständige Im Jahr 2020 wurden vier Werke in die ständige Sammlung für Kunst und Design des Quirinale (Residenz des Präsidenten der Italienischen Republik) aufgenommen: zwei SNOWSOUND ART-Paneele, entworfen von Gillo Dorfles, und zwei BOTANICA-Kompositionen, entworfen von Mario Trimarchi.

**E**\_Con obras expuestas en museos de diseño a nivel internacional, Caimi ha recibido decenas de reconocimientos y premios en todo el mundo, entre ellos tres Compasso d'Oro, tres German Design Awards y diecinueve ADI design Index. En 2020 cuatro obras entraron a formar parte de la colección permanente de Arte y Diseño del Palacio del Quirinale -la residencia del Presidente de la República Italiana-: dos paneles SNOWSOUND ART, con diseños de Gillo Dorfles y dos composiciones BOTANICA diseñadas por Mario Trimarchi.



2022 2016 2008



2022 2014 2016



2018 2016 2016



Download  
Company  
profile



Clicca e scarica  
il pdf.  
Click and download  
pdf file.

# DESIGNERS & design

**I**\_Le performance acustiche dei prodotti Snowsound prendono forma nei progetti di grandi designers. Una moltitudine di forme e colori pensati sia per essere parte visibile e caratterizzante del progetto, sia per integrarsi con discrezione negli ambienti. Risolvere le problematiche acustiche, dalle più semplici alle più complesse, con una gamma integrata di prodotti basati su un approccio del tutto innovativo.

**EN**\_Snowsound acoustic performance takes shape in projects thanks to great designers. Many shapes and colours are designed to be a visible and distinctive part of the project and to discreetly integrate into the spaces. Resolving acoustic problems, from the simplest to the most complex, with a complete range of products based on a totally innovative approach.

**F**\_Les performances acoustiques de Snowsound prennent forme dans les projets des grands designers. Une multiplicité de formes et de coloris conçus aussi bien pour être la partie visible et distinctive du projet, que pour s'intégrer discrètement dans les différents espaces. Résoudre les problématiques d'acoustique, des plus simples aux plus complexes, avec une gamme intégrée de produits basés sur une approche tout à fait innovante.

**D**\_Die akustische Wirkung von Snowsound nimmt in Projekten großer Designer Gestalt an. Eine Vielfalt an Formen und Farben ermöglichen die Gestaltung eines sichtbaren und charakteristischen Teil des Projekts ebenso wie eine diskrete Integration in den Räumen. Die Lösung von akustischen Problemen, von einfachen bis hin zu sehr komplexen, mit einer vollständigen Produktlinie, stellt einen vollkommen innovativen Ansatz dar.

**E**\_Las prestaciones acústicas de Snowsound se plasman en los proyectos de diseñadores afamados. Un sinnfin de formas y colores concebidos tanto para ser parte visible que caracteriza el proyecto, como también elemento que se integra con discreción en su entorno. Solucionar los problemas acústicos, de los más sencillos a los más complejos, con una gama integrada de productos basados en un enfoque muy innovador.



Gio Ponti



Anna Bartoli  
Paolo Bartoli



Mario Trimarchi



Michele De Lucchi



Paola Navone



Sezgin Aksu



Marc Sadler



Gillo Dorfles



Marta Martino



Francesco Mendini



Alberto Meda  
Francesco Meda



Annalisa Dominoni  
Benedetto Quaquaro



King & Miranda



Lorenzo Damiani



Alessandro Mendini



Felicia Arvid



Alessandro Zambelli



Manuela Zecca



Claudio Bellini



Moreno Ferrari



Lorenzo Palmeri

# OPEN LAB

## Research, Academy & No Profit



**I**\_Open Lab è uno spazio all'avanguardia che vanta 7 laboratori avveniristici dedicati alla ricerca teorica e applicata in ambito tecnologico, acustico e fisico. Un centro di ricerca volto a sperimentare il comportamento del suono, le capacità percettive dell'uomo e gli effetti che il suono ha sull'essere umano. In linea con le tradizioni della nostra azienda da sempre sensibile ai problemi sociali e con l'obiettivo di trovare soluzioni che contribuiscano a rendere migliore la qualità della vita, Open Lab è anche una struttura no profit gratuitamente messa al servizio di Università, Istituti di Ricerca, Fondazioni ed Enti. Open Lab, un grande laboratorio aperto al mondo, perché non esiste innovazione senza ricerca.

**EN**\_Open Lab is an advanced facility housing 7 futuristic laboratories dedicated to theoretical and applied research in technology, acoustics and physics. The purpose of the research facility is to carry out experiments on the behaviour of sound, on the perceptive capacities of humans, and on the effects of sound on people. In keeping with the traditions of our company, which has always been socially aware and has always aspired to solutions that improve the quality of life of all, Open Lab operates as a not-for-profit entity that is placed free of charge at the disposition of universities, research institutes, foundations and public-sector bodies. Open Lab: A laboratory complex whose doors are open to the world; without research, there can be no innovation.

**F**\_Open Lab est un lieu à l'avant-garde qui vante 7 laboratoires ultra-modernes dédiés à la recherche théorique et appliquée dans le domaine technologique, acoustique et physique. Un centre de recherche pour expérimenter le comportement du son, la capacité perceptive et les effets du son sur les êtres humains. En ligne avec les traditions de notre entreprise, depuis toujours sensible aux problèmes sociaux et à la recherche de solutions qui contribueront à améliorer la qualité de vie, Open Lab est en même temps une structure sans but lucratif au service des universités, instituts de recherche, fondations et autres organismes. Open Lab, un grand laboratoire ouvert au monde, car l'innovation ne peut exister sans la recherche.

**D**\_Open Lab ist ein Experimentierraum mit 7 zukunftsweisenden Labors, die sich mit theoretischer Forschung und ihrer Anwendung auf Technologie, Akustik und Physik befassen. Ziel des Forschungszentrums ist die Auslotung von Schallverhalten und menschlicher Wahrnehmung sowie der Auswirkungen von Schall auf den Menschen. Im Einklang mit der Tradition eines Unternehmens, das schon immer empfänglich war für soziale Themen und mit dem Ziel, Lösungen zu entwickeln, die zur Besserung der Lebensqualität beitragen, gestaltet sich Open Lab gleichzeitig als gemeinnützige Struktur, die kostenlos im Dienst von Universitäten, Forschungsinstituten, Stiftungen und Einrichtungen arbeitet. Open Lab ist ein großes, der Welt offenes Labor, weil es ohne Forschung keine Innovation gibt.

**E**\_Open Lab es un espacio vanguardista que cuenta con 7 laboratorios punteros orientados a la investigación teórica y aplicada en el ámbito tecnológico, acústico y físico. Un centro de investigación que permite experimentar el comportamiento del sonido, la capacidad de percepción del ser humano y los efectos que el sonido ejerce sobre este. De acuerdo con la tradición de nuestra empresa, siempre atenta a los problemas sociales y con el objetivo de encontrar soluciones que logren aportar mejoras a la calidad de vida, Open Lab es también una estructura sin ánimo de lucro que se pone al servicio de Universidades, Institutos de Investigación, Fundaciones y Entidades. Open Lab es también una estructura sin ánimo de lucro que se pone al servicio de Universidades, Institutos de Investigación, Fundaciones y Entidades. Open Lab es un gran laboratorio abierto al mundo, pues no existe innovación sin investigación.



**Guarda il video**



**Watch the video**



Clicca e guarda il video.

Click and watch the video.

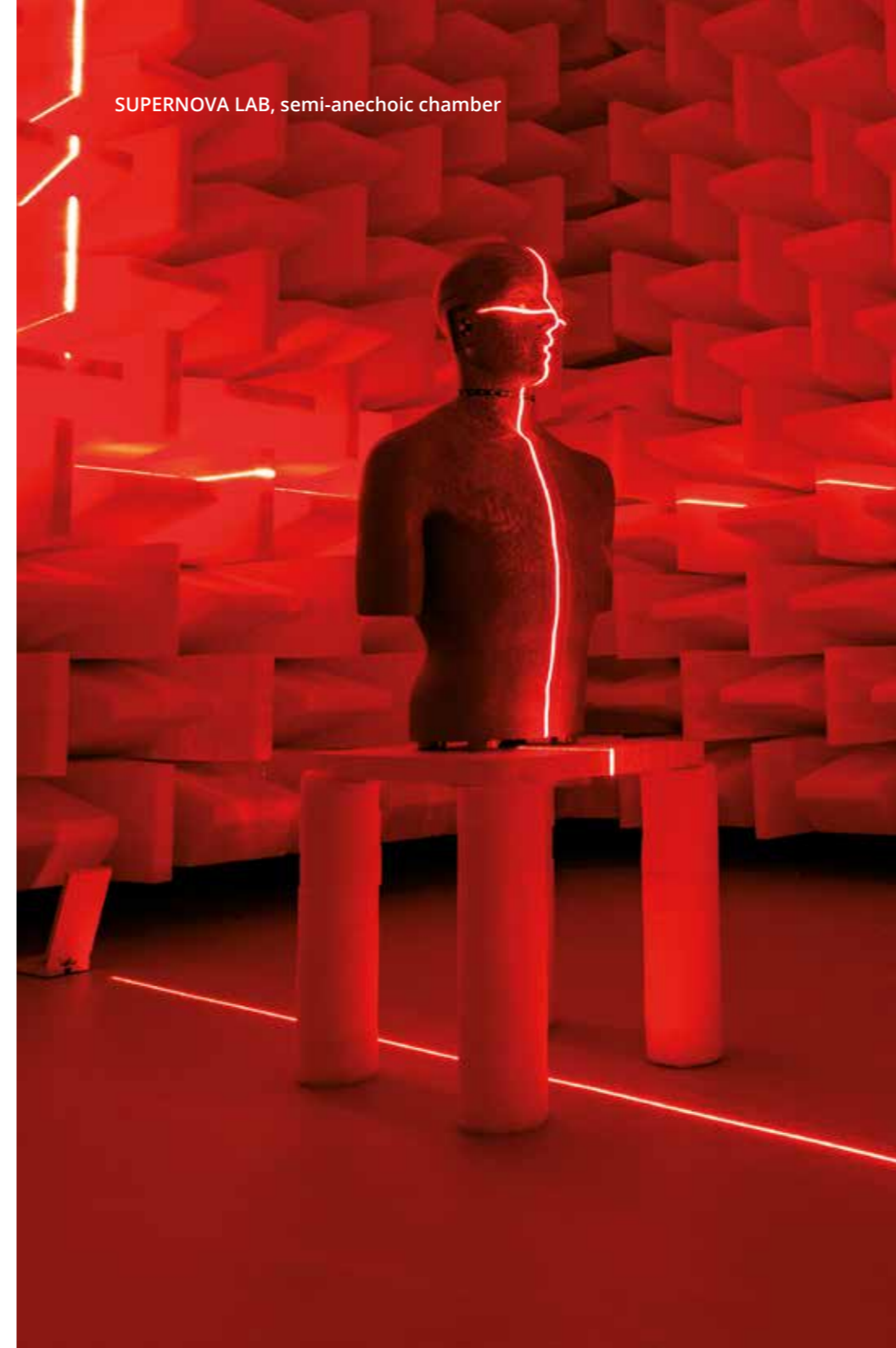

SUPERNOVA LAB, semi-anechoic chamber



MICROMAX LAB



REV LAB



HUB LAB

## WELLBEING TECHNOLOGIES

Acoustic comfort (Snowsound)

Electromagnetic reduction (A+E)

Air purification

**I** Le diverse tecnologie sviluppate da Caimi riguardanti il comfort acustico, la riduzione delle radiofrequenze e la purificazione passiva dell'aria sono studiate per contribuire in modo efficace al benessere delle persone e del loro habitat.

**EN** Caimi's technologies (acoustic comfort, radio frequency reduction and passive air purification) are designed to significantly improve people's wellbeing.

**F** Les différentes technologies développées par Caimi concernant le confort acoustique, la réduction des radiofréquences et la purification passive de l'air, ont été étudiées pour contribuer efficacement au bien-être des personnes et de leur habitat.

**D** Die verschiedenen von Caimi entwickelten Technologien für den akustischen Komfort, die Reduzierung von Hochfrequenzen und die passive Luftreinigung tragen wirksam zum Wohlbefinden der Menschen in ihrem Lebensraum bei.

**E** Las diversas tecnologías que Caimi desarrolla para el confort acústico, la reducción de las radiofrecuencias y la purificación pasiva del aire, están concebidas y diseñadas para contribuir de manera eficaz al bienestar de las personas en su entorno.



# SNOWSOUND

## Acoustic comfort

**I**\_Il comfort acustico è un'esigenza di benessere che riguarda tutti gli ambienti del vivere quotidiano. I pannelli, i tessuti e i divani fonoassorbenti Snowsound permettono di correggere in maniera rapida, funzionale e sicura i problemi legati all'acustica di ristoranti, bar, hotel, uffici, aree di attesa o di transito, ambienti pubblici e biblioteche, ma anche negozi e case. Lasciatevi ispirare dalle nostre proposte!

**EN**\_Acoustic comfort is fundamental for wellbeing within all environments in our daily lives. Snowsound sound absorbing panels, fabrics and sofas can solve acoustic-related problems correct in a quick, functional and safe way. This is achievable in restaurants, bars, hotels, offices, waiting/transit areas, public places and libraries, stores and houses. Let yourself be inspired by our designs!

**F**\_Le confort acoustique est une exigence pour le bien-être, qui concerne tous les lieux de la vie de tous les jours. Les panneaux, tissus et canapés phono-absorbants Snowsound permettent de corriger de manière rapide, fonctionnelle et en toute sécurité les problèmes liés à l'acoustique des restaurants, bars, hôtels, bureaux, zones d'attente ou de transit, lieux publics et bibliothèques, mais aussi des magasins et des habitations. Laissez-vous inspirer par nos propositions!

**D**\_Akustisches Wohlbefinden ist eine Anforderung, die alle Räume des Alltagslebens erfüllen müssen. Die Snowsound Schalldämpf-Platten, -Stoffe und -Sofas ermöglichen eine schnelle, effiziente und sichere Korrektur der Akustikprobleme von Restaurants, Bars, Hotels, Büros, Warte- oder Durchgangsräumen, öffentlichen Räumen und Bibliotheken, aber auch von Läden und Wohnungen. Lassen Sie sich von unseren Vorschlägen inspirieren!

**E**\_El confort acústico de todos los ambientes del diario vivir es una necesidad de bienestar. Los paneles, tejidos y sofás fonoabsorbentes Snowsound posibilitan la corrección rápida, funcional y segura de los problemas relacionados con la acústica de restaurantes, cafeterías, hoteles, oficinas, zonas de espera o de tránsito, locales públicos y bibliotecas, pero también de tiendas y viviendas. ¡Inspiraos en nuestras propuestas!

## LISTEN THE DIFFERENCE

without | with  
Snowsound Panels



without | with  
Snowsound Fiber Textiles



without | with  
Snowsound Sofas



Clicca e guarda  
il video.

Click and watch  
the video.

# A+E TECHNOLOGY

## Acoustic + Electromagnetic reduction



**I** Tessuto riduttore di radiofrequenze a base di tecnopolimero metallizzato in argento puro, specificatamente progettato per ridurre la potenza dei campi elettromagnetici provenienti dall'esterno senza tuttavia ostacolare completamente i segnali in modo da poter continuare ad utilizzare smartphone e reti Wi-Fi. Il tessuto riduttore di radiofrequenze viene inserito all'interno di divani, oggetti e pannelli fonoassorbenti, consentendo di combinare la funzione di riduzione del riverbero acustico a quella di riduzione dei campi elettromagnetici. Una nuova tecnologia brevettata pensata per il benessere delle persone.

**EN** Metallized high-tech polymer fabric with pure silver for radio frequency reduction. Specifically designed to reduce the power of electromagnetic fields. However, it doesn't completely obstruct signals, allowing the use of smartphones and Wi-Fi networks. This radio frequency reducing fabric can be included inside sofas and other sound absorbing elements, combining sound absorption with reduction of electromagnetic fields. A new patented technology for the wellbeing of people.

**F** Tissu réducteur des radiofréquences à base de technopolymère métallisé en argent pur, conçu expressément pour réduire la puissance des champs électromagnétiques provenant de l'extérieur sans empêcher complètement les signaux, de manière à pouvoir continuer à utiliser les téléphones portables et les réseaux Wi-Fi. Le tissu réducteur de radiofréquences est ajouté à l'intérieur des canapés, objets et panneaux phono-absorbants, permettant d'associer la fonction de réduction de la réverbération acoustique avec la réduction des champs électromagnétiques. Une nouvelle technologie brevetée, pensée pour le bien-être des gens.

**D** Hochfrequenzreduzierendes Gewebe auf der Basis von mit reinem Silber metallisiertem Technopolymer, das speziell entwickelt wurde, um die Stärke von elektromagnetischen Feldern von außen zu reduzieren, ohne jedoch Signale vollständig zu blockieren, so dass Smartphones und WLAN-Netzwerke weiterhin genutzt werden können. Das hochfrequenzreduzierende Gewebe wird in Sofas, Gegenständen und schallabsorbierenden Paneelen eingesetzt, wodurch die Reduzierung des akustischen Halls mit der Reduzierung elektromagnetischer Felder einhergeht. Eine neue, patentierte Technologie für das Wohlbefinden der Menschen.

**E** Tejido reductor de radiofrecuencias realizado a partir de tecnopolímero revestido con plata pura, concebido y diseñado para reducir la potencia de los campos electromagnéticos provenientes del exterior, sin bloquear por completo las señales para permitir, así, el funcionamiento de teléfonos móviles y redes Wi-Fi. El tejido reductor de radiofrecuencias se incorpora en el interior de sofás, paneles u objetos fonoabsorbentes, haciendo posible la combinación de las funciones de reducción de la reverberación acústica con la reducción de los campos electromagnéticos. Una novedosa tecnología patentada pensada para mejorar el bienestar de las personas.



**Guarda il video**



**Watch the video**



Clicca e guarda il video.

Click and watch the video.

| Standard Standard | Frequenza (MHz) (Start-Stop) Frequency | Attenuazione (%) Attenuation |
|-------------------|--|------------------------------|
| GSM / 850         | 825-895                                | 98,30 / 99,15                |
| GSM / 900         | 870-960                                | 96,45 / 96,66                |
| UMTS              | 1920-2170                              | 92,24 / 99,44                |
| LTE               | 2510-2690                              | 96,98 / 99,70                |
| WI-FI             | 2400-2500                              | 99,04 / 99,40                |
| 5G                | 3400-3800                              | 74,89 / 99,21                |
| WI-FI             | 5100-5800                              | 93,83 / 99,25                |

**I** Esempi di test eseguiti con Snowking / Snowcustom.

**EN** Example of test made on Snowking / Snowcustom.

### Available for

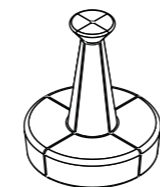

SNOWKING pag.280

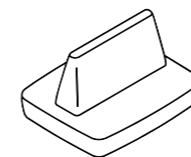

NAPWORK pag.272

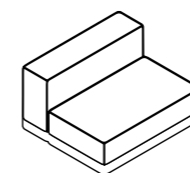

VOLUMI pag.276

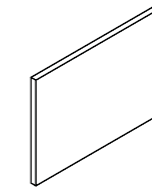

SNOWCUSTOM pag.74



SNOWCURTAINS pag.38



**A+E** optional



Clicca e vai alla pagina selezionata.

Click and go to the selected page.

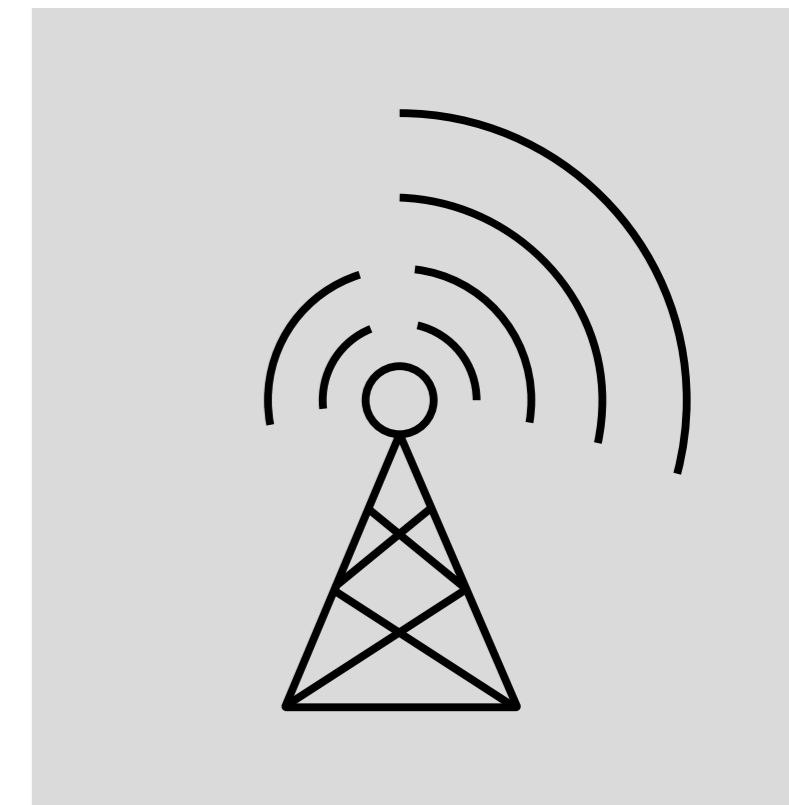

# AIR PURIFICATION TECHNOLOGY



**I** Il calore della lampada riscalda l'aria nella parte superiore generando un moto convettivo. L'aria così riscaldata passa attraverso un filtro realizzato in maglia di alluminio, galvanizzato e trattato con ioni d'argento, purificandosi.

**EN** The lamp heats the air in the upper part, generating a convective motion. The heated air passes through a filter made of galvanized aluminum mesh, treated with silver ions, purifying itself.

**F** La chaleur d'une lampe réchauffe l'air dans la partie supérieure, en créant un mouvement convectif. Cet air chaud est purifié en passant à travers un filtre en maille d'aluminium galvanisé et traité aux ions d'argent.

**D** Die Wärme der Lampe erhitzt die Luft im oberen Bereich und erzeugt eine Konvektionsbewegung. Die so erwärmte Luft strömt durch einen Filter aus galvanisiertem Aluminiumgewebe, das mit Silberionen behandelt wurde, und wird so gereinigt.

**E** La lámpara calienta el aire en la parte superior, generando un movimiento convectivo. El aire caliente pasa a través de un filtro de malla de aluminio galvanizado, tratado con iones de plata, purificándose.

**1** **I** Filtro di purificazione dell'aria.  
**EN** Air purification filter.  
**F** Filtre de purification de l'air.  
**D** Luftreinigungsfilter.  
**E** Filtro de purificación del aire.

**2** **I** Corpo illuminante LED.  
**EN** LED element.  
**F** Corps d'éclairage à LED.  
**D** LED-Leuchtkörper.  
**E** Cuerpo de iluminación LED.

**3** **I** Flusso dell'aria.  
**EN** Air flow.  
**F** Flux d'air.  
**D** Luftstrom.  
**E** Flujo de aire

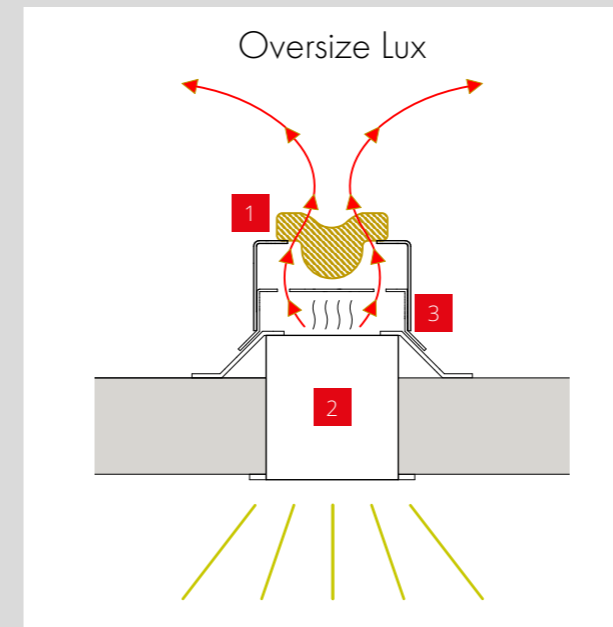
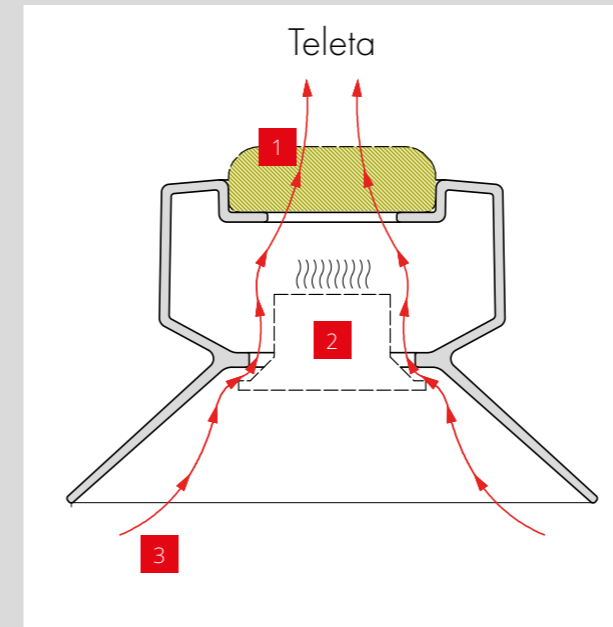

# SNOWSOUND SOFTWARE

## Your acoustic projects with Snowsound

**I\_Il benessere psicofisico** è un fattore essenziale che influenza le scelte architettoniche e gli spazi in cui viviamo. La progettazione coniuga sempre più gli aspetti estetici con quelli sensoriali, facendo spostare l'attenzione verso **soluzioni integrate** che siano in grado di far coesistere estetica e comfort. Caimi ha sviluppato **due software di calcolo** che mette liberamente a disposizione dei clienti per progettare l'acustica in ambienti nuovi o esistenti. La precisione dei software Snowsound è comprovata dagli oltre **100.000 calcoli acustici** effettuati nel corso degli anni, da **2 premi internazionali** ricevuti e dal nuovo laboratorio di ricerca **Open Lab** che permette di sviluppare ricerca sempre più avanzata.

**EN\_Psychophysical wellbeing** is an essential factor influencing architectural choices and the spaces we live in. Design is increasingly combining aesthetic and sensorial aspects, shifting the focus towards **integrated solutions** that allow aesthetics and comfort to coexist. Caimi developed **two acoustic design software** that are offered to customers completely free of charge, applicable to both new or existing environments. The precision of the software is proven by more than **100,000 acoustic calculations** made over the years, by the **2 international awards** received and by the new research laboratory **Open Lab** that allows to develop increasingly advanced research.

**F\_Le bien-être psychophysique** est un facteur essentiel qui influence les choix architecturaux et les espaces dans lesquels nous vivons. Le design combine de plus en plus les aspects esthétiques avec les aspects sensoriels, détournant l'attention vers des **solutions intégrées** capables de faire coexister esthétique et confort. Caimi a développé **deux logiciels de calcul** que l'entreprise met gratuitement à disposition de ses clients pour la conception de l'acoustique des locaux neufs ou existants. La précision du logiciel est prouvée par les plus de **100.000 calculs acoustiques** réalisés au fil des ans, par les **2 prix internationaux** reçus et par le nouveau laboratoire de recherche **Open Lab** qui permet de développer davantage et des recherches plus avancées.

**D\_Das körperliche Wohlbefinden** ist ein wesentlicher Faktor, der durch die architektonische Gestaltung der Räume, in denen wir leben und arbeiten, beeinflusst wird. Design kombiniert zunehmend ästhetische und sensorische Aspekte und verlagert den Fokus auf **integrierte Lösungen**, die das Nebeneinander von Ästhetik und Komfort ermöglichen. Caimi hat **zwei Arten von Analysesoftware** entwickelt, die das Unternehmen seinen Kunden kostenlos zur Verfügung stellt, um die Akustik in neuen oder bestehenden Räumen zu planen. Die Präzision der Software wird durch mehr als **100.000 akustische Berechnungen** bewiesen, welche im Laufe der Jahre erfolgreich durchgeführt wurden. Wir erhielten **2 internationalen Auszeichnungen** und unser eigenes Forschungslabor **Open Lab**, das die weitere Entwicklung und Präzisierung ermöglicht.

**E\_El bienestar físico y mental** es un factor esencial que tiene una gran influencia en las decisiones relativas a la arquitectura de los espacios en los que vivimos. El diseño combina cada vez más aspectos estéticos y sensoriales, cambiando el foco hacia **soluciones integrales** que permiten la coexistencia entre diseño y confort. Caimi posee dos software de análisis acústico que se ofrecen a los clientes de forma completamente gratuita, y que se pueden aplicar tanto a entornos nuevos como a otros ya existentes. La precisión de estas herramientas se ha demostrado gracias a los más de **100,000 estudios acústicos** que se han realizado a lo largo de los años, además de por sus **2 premios internacionales** y por el nuevo **Open Lab**, laboratorio de investigación en el que se desarrollan pruebas más avanzadas.



Go to the software



Clicca e vai al software.

Click and go to the software.



| Functionality<br>Funzionalità   | Acoustic calculation<br>Calcolo acustico | Acoustic analysis<br>Analisi acustica |
|---|--|---------------------------------------|
| Estimation of sound absorption material required<br>Stima del materiale fonoassorbente necessario                     | ✓  | ✓                                     |
| Possibility of combining different products and technologies<br>Possibilità di combinare più prodotti e tecnologie    | ✓  | ✓                                     |
| Graph with pre- and post-intervention reverberation curves<br>Grafico con curva di riverberazione pre/post intervento | -  | ✓                                     |
| Graph with dB reduction<br>Grafico con abbattimento in dB   | -  | ✓                                     |
| STI index calculation<br>Calcolo indice STI   | -  | ✓                                     |
| Rw index calculation<br>Calcolo indice Rw   | ✓  | ✓                                     |



## Acoustic analysis

**I** Il software di Analisi Acustica è uno strumento professionale in grado di stimare con grande precisione il tempo di riverbero pre intervento e quello post intervento ottenibile grazie all'utilizzo dei diversi prodotti SNOWSOUND, anche combinati fra di loro. Il software fornisce anche la stima dell'indice di intelligibilità del parlato **STI** e la riduzione del livello di pressione sonora in **dB** all'interno dell'ambiente trattato. Nel caso di tende realizzate con la tecnologia Snowsound Fiber Textiles il software è in grado di calcolare l'indice **Rw** che definisce la capacità di abbattimento acustico della configurazione scelta.

**EN** CAIMI's Acoustic Analysis software is a professional tool that accurately estimates reverberation time curves before and after installing different SNOWSOUND products, eventually combining them together. The software also predicts the speech intelligibility index (**STI**) and reduction of sound pressure levels in **dB** within any given space. In case of curtains made with Snowsound Fiber Textiles, the software calculates the **Rw** value, which determines the effectiveness of the specific configuration as a noise insulator.

**F** Le logiciel d'Analyse Acoustique est un outil professionnel en mesure d'estimer avec une grande précision le temps de réverbération avant et après l'intervention, qu'on peut obtenir en utilisant les différents produits SNOWSOUND, même quand ils sont combinés entre eux. Le logiciel fournit également une estimation de l'indice de transmission de la parole **STI** (Speech Transmission Index) et la réduction du niveau de la pression acoustique en **dB** dans l'environnement concerné. Pour les rideaux réalisés avec la technologie Snowsound Fiber Textiles, le logiciel peut calculer l'indice **Rw** qui définit l'affaiblissement sonore de la configuration choisie.

**D** Die Akustik-Analyse-Software ist ein professionelles Werkzeug, mit dem die Nachhallzeit vor dem Eingriff und die Nachhallzeit nach dem Eingriff, die mit den verschiedenen SNOWSOUND-Produkten, auch in Kombination miteinander, erreicht werden kann, mit großer Genauigkeit abgeschätzt werden kann. Die Software ermöglicht auch die Schätzung des Sprachverständlichkeitsindex **STI** und der Verringerung des Schalldruckpegels in **dB** innerhalb der betrachteten Umgebung. Bei Vorhängen, die mit Snowsound Fiber Textiles-Technologie hergestellt werden, kann die Software den **Rw**-Index berechnen, der das Schalldämmvermögen der gewählten Konfiguration bestimmt.

**E** El software de análisis acústico de Caimi es una herramienta profesional que estima con excelente precisión el tiempo de reverberación antes y después de la intervención de corrección acústica mediante el uso de diferentes productos SNOWSOUND, solos o combinados entre sí. El software también permite estimar el índice de intelegibilidad de una conversación (**STI**), así como la reducción de los niveles de presión sonora, en decibelios (**dB**), dentro del espacio a intervenir. En el caso de las cortinas realizadas con los tejidos acústicos con tecnología Snowsound Fiber Textiles, el software puede calcular el índice **Rw**, que determina la capacidad de aislamiento acústico de la configuración elegida.

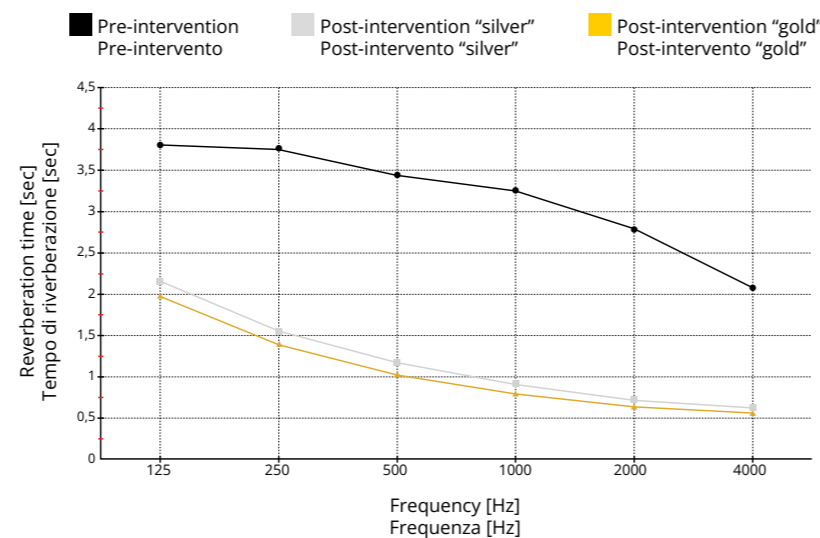
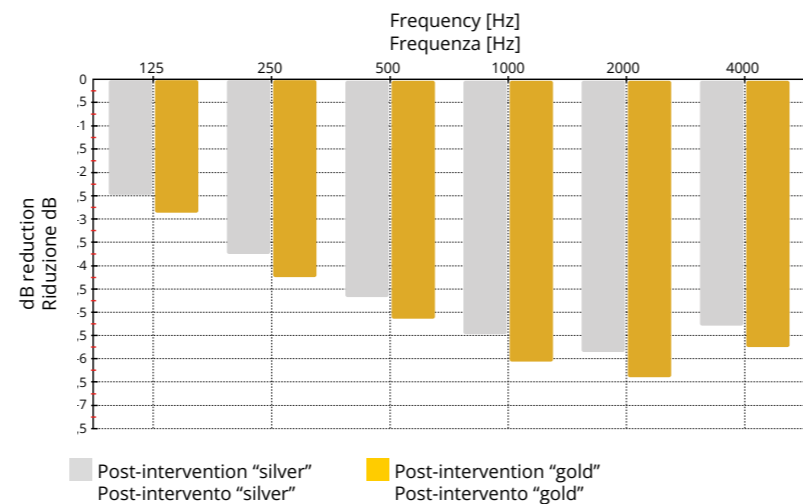

## Acoustic calculation

**I** Il software di Calcolo Acustico è uno strumento **rapido e immediato** in grado di determinare il quantitativo ideale di prodotti fonoassorbenti Snowsound da utilizzare partendo da solo tre dati: dimensione dell'ambiente, destinazione d'uso e prodotto scelto.

**EN** The Acoustic Analysis software is a **quick and easy way** to calculate the ideal amount of Snowsound sound-absorbing products. Only three needed data: room size, use, and the CAIMI product of choice.

**F** Le logiciel de Calcul Acoustique est un outil **rapide et immédiat** en mesure de déterminer la quantité idéale des produits phono-absorbants Snowsound à utiliser en se basant sur trois données seulement: les dimensions de la pièce, l'utilisation prévue et le produit choisi.

**D** Die Akustikberechnungssoftware ist ein **schnelles und unmittelbares** Werkzeug, mit dem die ideale Menge an Snowsound-Akustikprodukten anhand von nur drei Daten ermittelt werden kann: Raumgröße, Verwendungszweck und gewähltes Produkt.

**E** El software de cálculo acústico es una herramienta **rápida y sencilla** que permite determinar la cantidad óptima de productos fonoabsorbentes Snowsound, a partir de tan solo tres datos: tamaño del espacio a intervenir, uso previsto y producto/s elegido/s.



## SELECT AND MIX THE PRODUCTS

Our software calculates your acoustic solution

**I** Non solo pannelli fonoassorbenti, ma sistemi completi che comprendono illuminazione, tessuti, tendaggi e arredi: con i prodotti SNOWSOUND il progetto acustico è in grado di soddisfare le esigenze estetiche e funzionali di ogni ambiente. Il nostro software di calcolo consente di combinare tra loro tutti i prodotti del catalogo SNOWSOUND ed è in grado di eseguire un calcolo acustico che si basa su precisi test effettuati su ogni singolo prodotto. Il cliente deve semplicemente scegliere i prodotti più adatti alle proprie esigenze demandando al software di calcolo l'analisi acustica dell'ambiente.

**EN** Not just sound-absorbing panels, but complete systems that include lighting, fabrics, curtains and furnishings. With SNOWSOUND, the acoustic design incorporates aesthetic and functional needs for any environment. Our calculation software combines all the products in the SNOWSOUND catalogue and it performs an acoustic calculation based on precise tests carried out on each individual product. The customer simply has to choose the desired products while the calculation software takes care of the acoustic analysis and it estimates the required quantities.

**F** Il ne s'agit pas seulement de panneaux phono-absorbants, mais de systèmes complets comprenant l'éclairage, les tissus, les rideaux et le mobilier: grâce aux produits SNOWSOUND, le projet acoustique peut répondre aux exigences esthétiques et fonctionnelles de tout type d'intérieur. Notre logiciel de calcul permet de combiner entre eux tous les produits du catalogue SNOWSOUND et peut effectuer un calcul acoustique basé sur des tests précis réalisés sur chacun de nos produits. Le client doit uniquement choisir les produits qui répondent au mieux à ses exigences en laissant l'analyse acoustique de la pièce au logiciel de calcul.

**D** Nicht nur schallabsorbierende Paneele, sondern Komplettsysteme mit Beleuchtung, Stoffen, Vorhängen und Möbeln: Mit SNOWSOUND-Produkten wird das Akustikdesign den ästhetischen und funktionalen Anforderungen eines jeden Raumes gerecht. Mit unserer Analysesoftware können sämtliche Produkte des SNOWSOUND-Katalogs miteinander kombiniert werden und eine akustische Berechnung durchgeführt werden, die auf präzisen Tests an jedem einzelnen Produkt basiert. Sie wählen lediglich die Produkte aus, die Ihren Bedürfnissen am besten entsprechen, und die Software führt die entsprechende akustische Raumanalyse durch.

**E** No solo paneles fonoabsorbentes, sino también sistemas completos que abarcan iluminación, tejidos, cortinas y elementos de decoración: con los productos SNOWSOUND el proyecto acústico se encuentra con las necesidades estéticas y funcionales de cada estancia. Nuestro software de cálculo permite combinar entre sí todos los productos de la familia SNOWSOUND y realizar un cálculo acústico basado en precisos ensayos, realizados para cada objeto en particular. El cliente debe, sencillamente, seleccionar los productos más adecuados a sus necesidades y confiar al software de cálculo el análisis acústico del ambiente.



Watch  
the video



Clicca e guarda  
il video.

Click and watch  
the video.

Panels



Sofas



Furniture



ACOUSTICS  
AROUND YOU

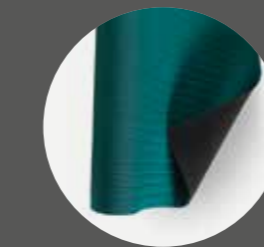

Wall Coverings



Curtains

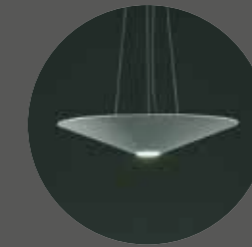

Lamps

# SUSTAINABILITY

## Environmentally conscious design

**I**\_Caimi, da sempre sensibile nei confronti delle tematiche ambientali e dell'ecosostenibilità, utilizza, dove tecnicamente possibile, materiali riciclabili o riutilizzabili. La produzione è composta in prevalenza da oggetti monomaterici, facilmente riciclabili: gli oggetti composti da più materiali sono in larga parte pensati per essere disassemblabili, consentendo di riciclare separatamente i singoli componenti. I prodotti Snowsound Technology, i tessuti Snowsound Fiber e Snowall hanno ricevuto la certificazione Greenguard Gold, che convalida le loro caratteristiche di bassa emissione ed il loro contributo alla qualità dell'ambiente.

**EN**\_Caimi has always had an attentive eye for environmental issues and ecosustainability. This is why, if technically feasible, we use recyclable or reusable materials. Production consists mainly of single-material, easily recyclable objects: objects made of multiple materials are in most cases designed to be disassembled. This allows separate recycling of the individual components. Snowsound Technology, Snowsound Fiber fabrics and Snowall products have received Greenguard Gold certification, indicating that they are low emitting products and do contribute to improve indoor air quality.

**F**\_Caimi, depuis toujours sensible aux thématiques de l'environnement et de l'éco-durabilité, utilise, quand c'est techniquement possible, des matériaux recyclables ou réutilisables. La production est composée surtout d'objets monomatériaux, facilement recyclables, et les objets composés de plusieurs matériaux sont généralement pensés pour être désassemblés, ce qui permet donc de recycler séparément chaque composant. Les produits Snowsound Technology, les tissus Snowsound Fiber et Snowall ont reçu la certification Greenguard Gold qui confirme leurs caractéristiques de faible émission et donc leur apport à la qualité de l'environnement.

**D**\_Caimi ist seit jeher mit Umweltthemen und der Umweltverträglichkeit vertraut und verwendet, wo technisch möglich, wiederverwertbare oder recyclebare Materialien. Die Produktion besteht überwiegend aus Monomaterial- Gegenständen, die leicht recyclebar sind: die Gegenstände aus mehreren Materialien sind zum Großteil so entwickelt, dass sie auseinander gebaut werden können, wodurch das Recycling der einzelnen Komponenten ermöglicht wird. Die Produkte Snowsound Technology, die Snowsound Fiber Stoffe und Snowall sind mit der Greenguard Gold-Zertifizierung ausgezeichnet worden, die die Anwendung von Materialien mit geringen chemischen Emissionen und deren Beitrag zur verbesserten Raumqualität bezeugt.

**E**\_Caimi, debido a su constante preocupación por los temas medioambientales y la ecosostenibilidad, se utilizan, siempre que sea técnicamente posible, materiales reciclables o reutilizables. La producción está compuesta en su mayoría por objetos monomatericos, fácilmente reciclables: los objetos compuestos por varios materiales están en su mayoría pensados para ser desensamblados, permitiendo reciclar por separado cada componente. A los productos Snowsound Technology, los tejidos Snowsound Fiber y Snowall se les ha otorgado el certificado Greenguard Gold, que garantiza sus características de baja emisión y su contribución a la calidad del ambiente.



**Guarda  
il video**



**Watch  
the video**



Clicca e guarda  
il video.

Click and watch  
the video.

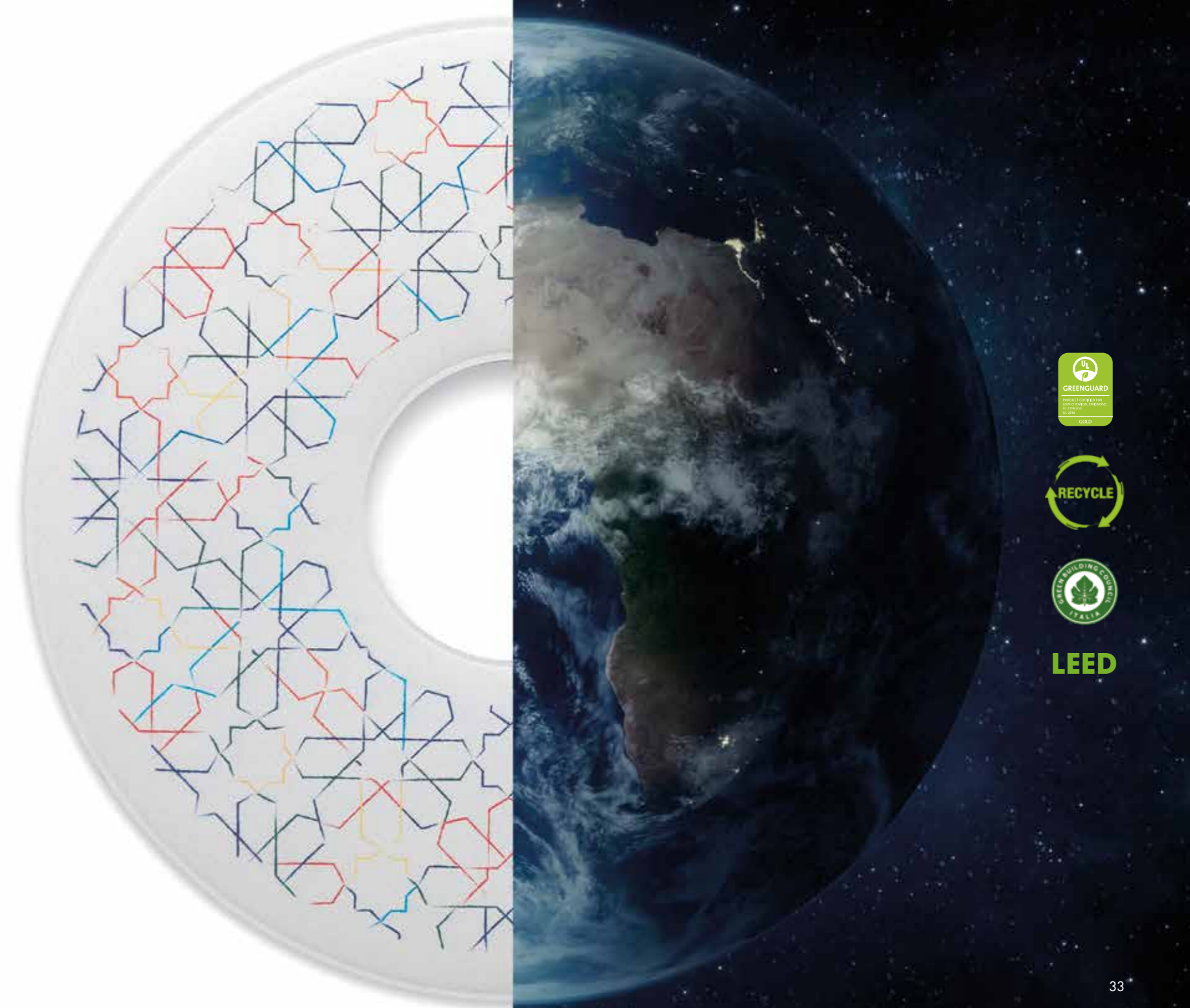

## NO-PROFIT RESEARCH

### Social sustainability

**I**\_Nell'ottica della sensibilità per il sociale da sempre presente nel DNA della nostra società, l'operatività dei laboratori Open Lab non è un'esclusiva della Caimi, ma costituisce una struttura NO PROFIT messa a disposizione di Università, Istituti di Ricerca, Fondazioni ed Enti che ne possono usufruire per studi e ricerche, in special modo nel campo del suono e dell'acustica, al fine di individuare nuove soluzioni per il miglioramento della salute e del benessere psicofisico delle persone. Collaborazioni in corso con Politecnico di Milano, Università IUAV di Venezia e Università di Genova.

**EN**\_In keeping with the Company's deeply rooted commitment to open engagement with society, Open Lab doesn't not work exclusively on behalf of Caimi, but also serve as a non-profit facility at the disposition of universities, research institutes, foundations and public bodies, which may use the laboratories for study and research purposes, especially in the field of sound and acoustics, and in their search for new ways of improving human health and psychophysical wellbeing. Ongoing collaborations with Politecnico of Milan, University IUAV of Venice and University of Genoa.

**F**\_Dans le respect de la sensibilité sociale, depuis toujours présente dans l'ADN de notre entreprise, les laboratoires Open Lab ne seront pas exclusivement limités à Caimi, mais formeront une structure SANS BUT LUCRATIF mise à la disposition des Universités, des Instituts de recherche, des Fondations et des Organismes qui pourront l'utiliser pour des études et des recherches, notamment dans le domaine du son et de l'acoustique, afin d'identifier de nouvelles solutions pour l'amélioration de la santé et du bien-être psychophysique des personnes. Les collaborations sont en cours avec le Politecnico de Milan, l'Université IUAV de Venise et l'Université de Gênes.

**D**\_Im Einklang mit der im Unternehmen tief verankerten Überzeugung des offenen Engagements mit der Gesellschaft, werden die Open Lab-Labors nicht ausschließlich Caimi dienen, sondern als gemeinnützige Einrichtung Universitäten, Forschungsinstituten, Stiftungen oder Behörden zur Verfügung stehen, die sie für Untersuchungen und Forschungen nutzen können werden, insbesondere um neue Lösungen im Bereich von Akustik und Schall zu entwickeln, die zur Besserung von Gesundheit und körperlichem und geistigem Wohlbefinden der Menschen beitragen. Laufende Zusammenarbeit mit dem Polytechnikum Mailand, der Universität IUAV von Venedig und der Universität Genua.

**E**\_Nuestra empresa siempre tuvo en su ADN una atención especial por el ámbito social y por ello, la actividad de los laboratorios Open Lab, no será algo exclusivo de Caimi sino que se creará una estructura SIN FINES DE LUCRO al servicio de las Universidades, Institutos de Investigación, Fundaciones y Entes para sus estudios e investigaciones, en particular en el ámbito del sonido y de la acústica, para identificar soluciones nuevas que mejoren la salud y el bienestar psíquico y físico de las personas. Colaboraciones en curso con la Universidad Politécnica de Milán, la Universidad IUAV de Venecia y la Universidad de Génova.



## HIGH PERFORMANCE LESS MATERIAL

### Convenience thanks to sustainable consumption

**I**\_Le elevate performance acustiche delle tecnologie brevettate Snowsound permettono di ottenere un comfort acustico ottimale con quantità ridotte di materiale fonoassorbente, rispetto ai prodotti tradizionali. Il contenimento del materiale impiegato ha un impatto positivo sulla sostenibilità ambientale, sui costi e sui tempi di installazione.

**EN**\_High-performing Snowsound-patented technologies deliver optimal acoustic comfort while using less sound-absorbing material than traditional products. Reduced volumes of material use are environmentally sustainable, and lower both costs and installation times.

**F**\_Les performances acoustiques élevées des technologies brevetées Snowsound permettent d'atteindre un confort acoustique optimal avec des quantités réduites de matériau phono-absorbant par rapport aux produits conventionnels. La réduction des matériaux utilisés a un impact positif sur la durabilité environnementale, sur les coûts et les temps d'installation.

**D**\_Die hohe akustische Leistung der patentierten Snowsound-Technologien ermöglicht es, mit einer geringeren Menge an schallabsorbierendem Material als bei herkömmlichen Produkten einen optimalen akustischen Komfort zu erreichen. Die Verringerung des Materialeinsatzes wirkt sich positiv auf die Umweltverträglichkeit, die Kosten und die Installationszeit aus.

**E**\_Las elevadas prestaciones acústicas de la tecnología patentada Snowsound permiten obtener un excelente confort acústico, con menor cantidad de material fonoabsorbente que los productos tradicionales. La disminución del material empleado repercute positivamente en la sostenibilidad medioambiental, así como en los costes y el tiempo de instalación.



# Snowcurtains

Custom made acoustic curtains

**I** Tende realizzate con tessuti fonoassorbenti Snowsound Fiber, prodotte su misura in base alle specifiche esigenze del cliente.  
Il software di configurazione consente, in modo semplice e rapido, di codificare e preventivare le tende acustiche Snowcurtains.

**EN** Curtains made with Snowsound Fiber sound-absorbing fabrics, made to measure according to the specific needs of the customer.  
The configuration software allows you to quickly and easily code and quote Snowcurtains.

**F** Rideaux en tissus phono-absorbants Snowsound Fiber, fabriqués sur mesure selon les besoins spécifiques du client.  
Le logiciel de configuration permet d'établir et de codifier de manière simple et rapide un devis des rideaux acoustiques Snowcurtains.

**D** Vorhänge aus Snowsound Fiber Akustikstoffen, maßgeschneidert nach Kundenwunsch.  
Die Konfigurationssoftware ermöglicht eine schnelle und einfache Codierung und Berechnung von Snowcurtains Akustikvorhängen.

**E** Cortinas realizadas con tejidos fonoabsorbentes Snowsound Fiber, hechas a medida según las especificaciones del cliente.  
El software de configuración permite, de forma rápida y sencilla, codificar y presupuestar las cortinas acústicas Snowcurtains.



Download  
Snowcurtains  
brochure



Clicca e scarica  
il pdf.

Click and download  
pdf file.

# DRAPERY



**A+E** optional  
Info pag. 22



Clicca e vai alla  
pagina selezionata.

Click and go to the  
selected page.

**I**\_Sistema per tende manuali a strappo. Le tende sono realizzate con tessuti acustici Snowsound Fiber e arricciate con ricchezza da 1,9 a 2,1. I binari, realizzati in alluminio, possono essere fissati direttamente a parete/soffitto oppure sospesi a soffitto tramite appositi supporti.

**EN**\_Manual curtain system, operated through fabric pulling. The curtains are made with Snowsound Fiber acoustic fabrics using a fabric consumption between 1.9 and 2.1 times the length. The aluminium tracks can be fixed directly to the wall/ceiling or suspended from the ceiling using specific supports.

**F**\_Système pour rideaux manuels auto-agrippants, sans mécanisme. Les rideaux sont assemblés avec les tissus acoustiques Snowsound Fiber et plissés avec un facteur de 1,9 à 2,1. Les rails en aluminium peuvent être fixés directement au mur/plafond ou suspendus au plafond à l'aide de supports spéciaux.

**D**\_Vorhänge zum Zuziehen per Hand, ohne Mechanismus. Die Vorhänge bestehen aus Snowsound Fibre Akustikstoffen mit einem Faltenwurf von 1,9 bis 2,1 Mal. Die aus Aluminium gefertigten Schienen können direkt an der Wand/Decke befestigt oder mit Hilfe spezieller Halterungen mit Abstand von der Decke montiert werden.

**E**\_Sistema de cortina con accionamiento manual, sin mecanismo. Las cortinas están realizadas con tejido acústico Snowsound Fiber y drapeadas con una holgura de 1,9 a 2,1 cm. Los rieles de aluminio pueden anclarse directamente a la pared o al techo, o bien colgarse de este último utilizando los soportes previstos para este fin.

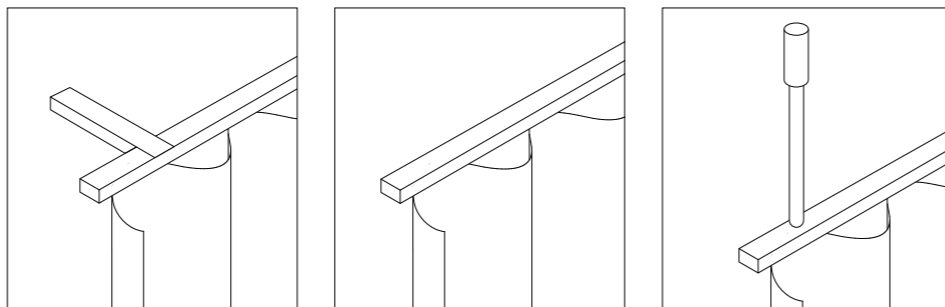



Identità Golose, Milano (Italy)



BMW Financial Service - "Central Spine", Milano (Italy)



Restaurant Chai, Gembloux (Belgium)



Gensler, Miami (U.S.A.)





## ROLLER SHADES



**I**\_Tende a rullo con comando a catenella, realizzate in tessuto acustico Snowsound Fiber 2R. Il sistema è realizzato in alluminio, acciaio e tecnopolimero e può essere fissato direttamente a parete/soffitto.

**EN**\_Roller shades with chain movement, made of Snowsound Fiber 2R acoustic fabric. The system is made of aluminium, steel and high-tech polymer. It can be fixed directly to the wall/ceiling.

**F**\_Stores enrouleurs avec commande à chaînette assemblés avec le tissu acoustique Snowsound Fiber 2R. Le système est réalisé en aluminium, acier et technopolymère et peut être appliqué directement au mur ou au plafond.

**D**\_Rollos mit Kettenzug, hergestellt aus Snowsound Fiber 2R Akustikstoff. Das System ist aus Aluminium, Stahl und Technopolymer gefertigt und kann direkt an der Wand/Decke befestigt werden.

**E**\_Cortinas enrollables con cadena, realizadas en tejido acústico Snowsound Fiber 2R. El sistema de aluminio, acero y tecnopolímero puede colocarse directamente en la pared o al techo.





Hotel Cruise, Montano Lucino CO (Italy)

# Snowsound Fiber

Acoustic textiles

I materiali Snowsound Fiber, a seconda delle loro specifiche tecniche, possono essere inseriti in diversi ambienti, connotandone lo stile e diventando parte integrante del progetto d'arredo. I materiali Snowsound Fiber sono proposti in diverse tipologie per diversi utilizzi; si possono lavorare e posare in opera in modo creativo, creando anche effetti d'arredo coordinati.

EN Snowsound Fiber materials have different technical properties, thus permitting different uses for different environments, characterizing with style of a given space and becoming part of the interior design. Therefore Snowsound Fiber materials come with different features according to the need; it can be installed in creative ways in coordination with the furniture.

F Les matériaux Snowsound Fiber, en fonction des leurs propriétés techniques, peuvent être placés dans des espaces différents, en en caractérisant le style et devenant partie du projet d'ameublement. Les matériaux Snowsound Fiber sont disponibles dans différents types pour différents emplois: on peut façonner les tissus et les utiliser d'une manière créative, créant également des effets décoratifs coordonnés.

D Snowsound Fiber-Materialien können, je nach ihren spezifischen technischen Eigenschaften, in verschiedenen Räumen Einsatz finden, indem sie deren Stil definieren und zum wesentlichen Bestandteil des Einrichtungsentwurfs werden. Snowsound Fiber-Materialien werden in verschiedenen Modellen für verschiedenartige Einsätze geliefert; sie können kreativ verlegt und verarbeitet werden, auch um koordinierte Einrichtungseffekte zu erzeugen.

E Los materiales Snowsound Fiber poseen diferentes propiedades técnicas que permiten diferentes usos para diferentes entornos, confiriendo carácter y estilo a los diferentes espacios y formando parte del diseño de interiores. De esta forma, los materiales Snowsound Fiber se puede aplicar en diferentes configuraciones de acuerdo a las necesidades, puede instalarse de forma creativa en conjunto con el resto del mobiliario.



Download  
Snowsound Fiber  
samples



Clicca e scarica  
il pdf.

Click and download  
pdf file.

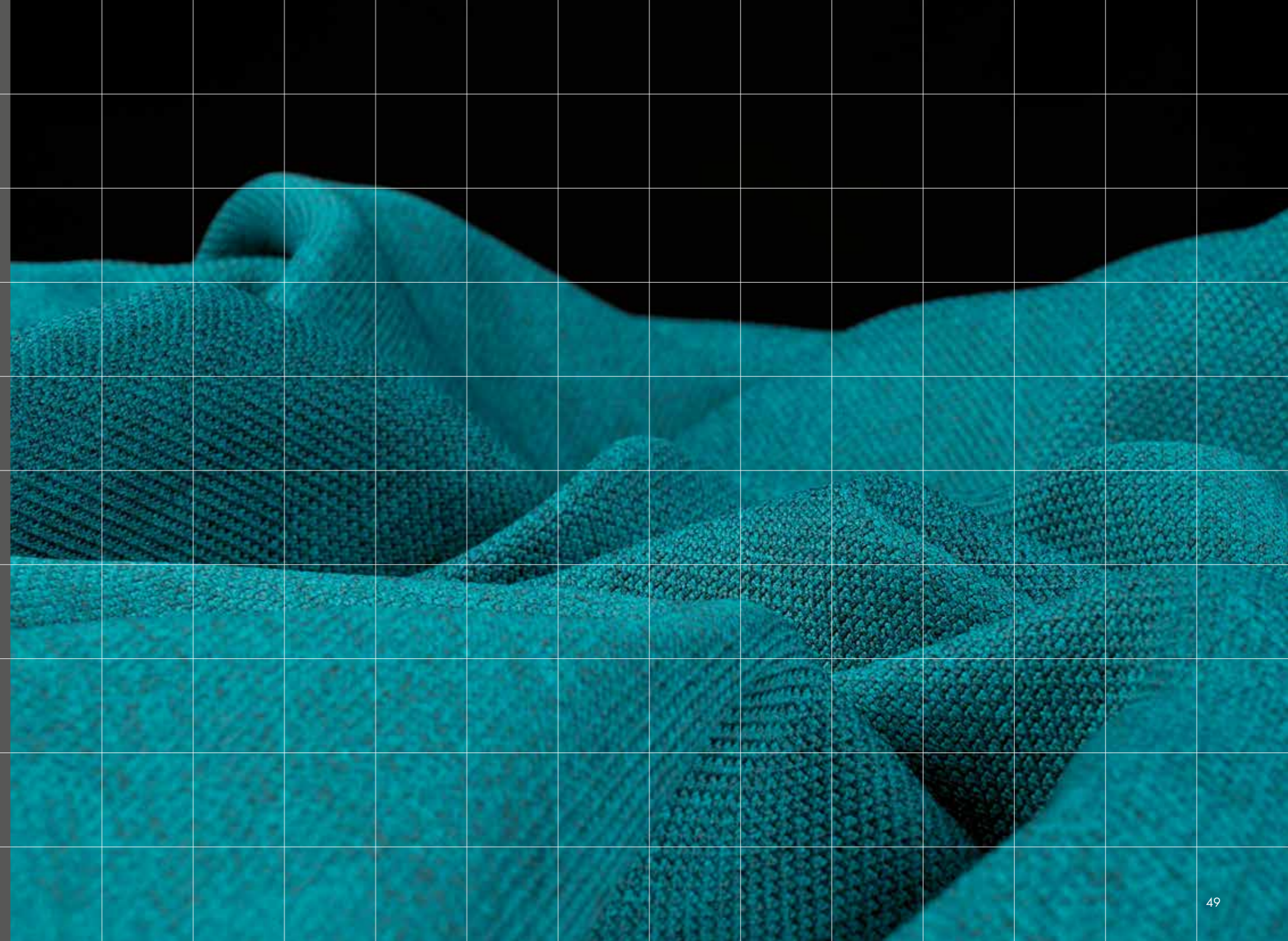

# FIBER 7 VELO

## 100% Polyester



**I**\_Tessuto acustico leggero e semi-trasparente, satinato e brillante, caratterizzato da una texture fine in tinta unita, con lievi fiammature di colore. L'effetto "VELO" elimina le barriere visive tra outdoor e indoor. Il tessuto presenta due lati diversi, uno più opaco rivolto all'interno della stanza e uno più lucido e riflettente rivolto verso la finestra per migliorare il comfort termico e la sostenibilità energetica.

**EN**\_Lightweight and semi-transparent acoustic fabric, satin and shiny, characterized by a fine texture in solid colour, with light colour effects. The "VELO" (veil) effect eliminates visual barriers between outdoor and indoor. The fabric has two different sides, a more opaque one facing inside and a more shiny and reflective one facing the window. This improves thermal comfort and energy sustainability.

**F**\_Tissu acoustique léger, semi-transparent, satiné et brillant, caractérisé par une texture fine dans des couleurs unies, avec de légers éclats de couleur. L'effet "VOILE" élimine les barrières visuelles entre l'extérieur et l'intérieur. Le tissu a deux côtés différents, un plus opaque orienté vers l'intérieur de la pièce et l'autre plus brillant, plus réfléchissant, orienté vers la fenêtre, afin d'améliorer le confort thermique et la durabilité énergétique.

**D**\_Leichtes, halbtransparentes, satiniertes und glänzendes Akustikgewebe, das sich durch eine feine Struktur in Unifarben mit leichten Farbakzenten auszeichnet. Der Schleier-Effekt hebt visuelle Barrieren zwischen Außen- und Innenräumen auf. Das Gewebe hat zwei leicht unterschiedliche Seiten, eine mattere Seite zum Rauminnen hin und eine glänzendere, reflektierende Seite in Richtung Fenster, um den thermischen Komfort und die Energie-Nachhaltigkeit zu verbessern.

**E**\_Tejido acústico ligero y semi-transparente, satinado y brillante, caracterizado por una fina textura de color liso, con colores suavemente flameados. El efecto "VELO" elimina las barreras visuales entre exteriores e interiores. El tejido presenta dos caras distintas: una mate hacia el interior de la habitación y otra brillante mirando hacia la ventana para mejorar el confort térmico y la sostenibilidad energética.

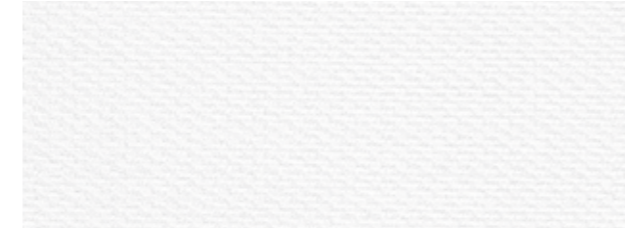

Colour 700



Colour 704



Colour 702



Colour 701



Colour 703

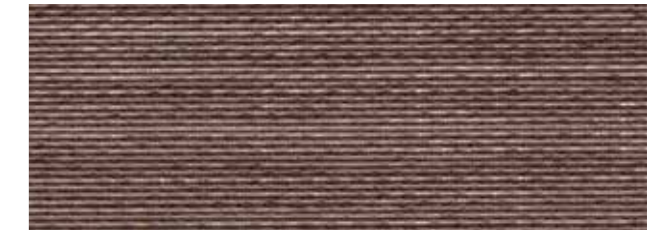

Colour 705



Colour 706

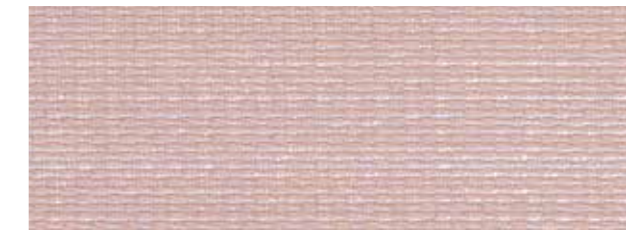

Colour 708



Colour 707

**FIBER 2 LINE**  
100% Polyester



**FIBER 2R LINE-R**  
100% Polyester



Colour 200



Colour 201



Colour 202

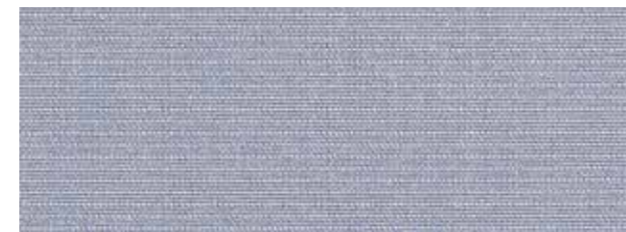

Colour 203



Colour 200



Colour 201



Colour 202



Colour 203

**FIBER 8 BOUCLÉ**  
100% Polyester

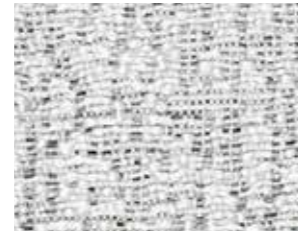

Colour 810

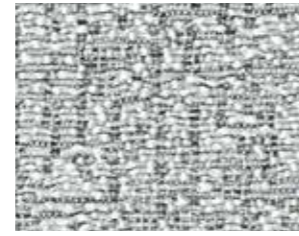

Colour 811



Colour 812



Colour 813

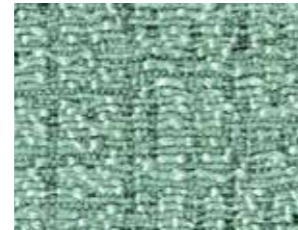

Colour 815

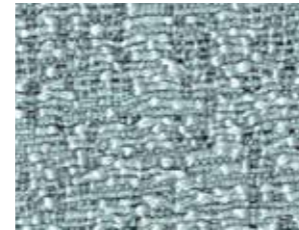

Colour 814

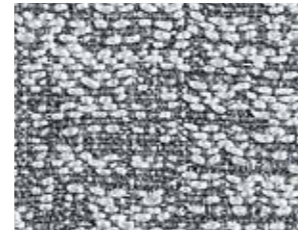

Colour 801

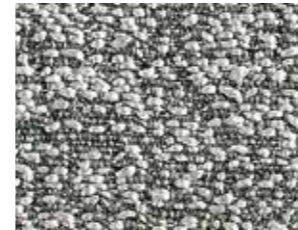

Colour 802



Colour 800



Colour 803



Colour 807

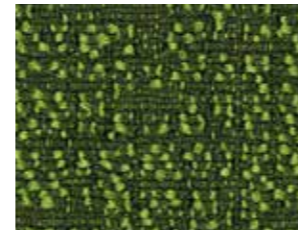

Colour 804

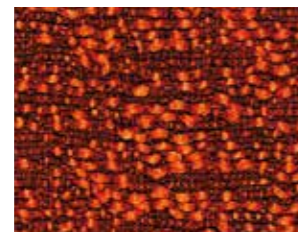

Colour 809

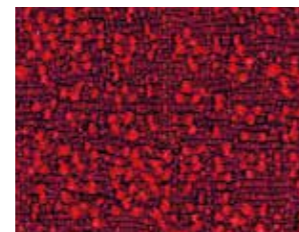

Colour 808



Colour 805

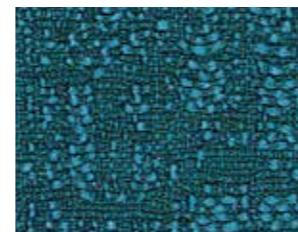

Colour 806

**FIBER 3 MELANGE**  
100% Polyester



Colour 316



Colour 309



Colour 315



Colour 313

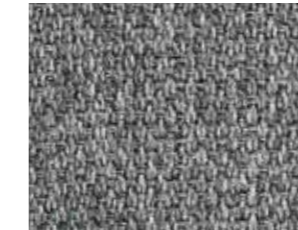

Colour 300

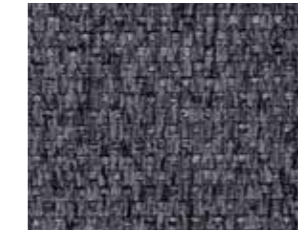

Colour 311



Colour 308



Colour 302



Colour 314



Colour 305



Colour 303

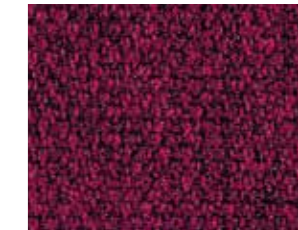

Colour 306



Colour 312



Colour 307



Colour 310



Colour 304

**FIBER 6 VELVET**  
100% Polyester



Colour 600



Colour 606



Colour 608



Colour 610



Colour 603



Colour 609



Colour 611



Colour 607

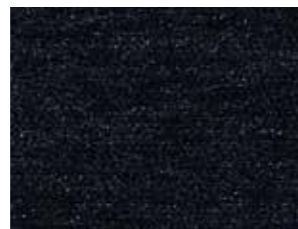

Colour 602



Colour 601



Colour 604



Colour 605

**FIBER 1 COLOR**  
100% Polyester



Colour 4027

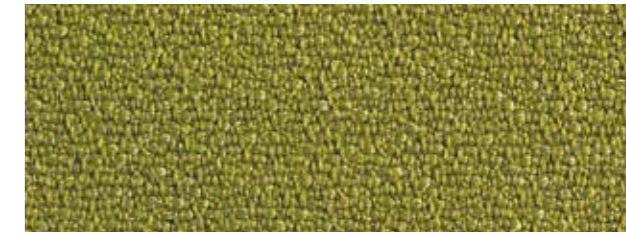

Colour 7004

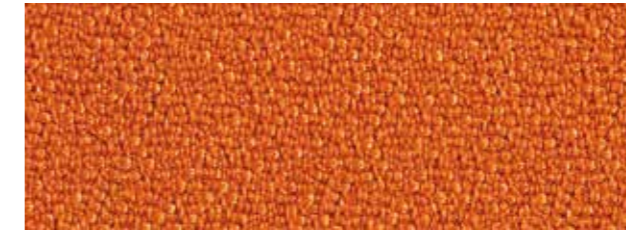

Colour 4030



Colour 8004



Colour 3008

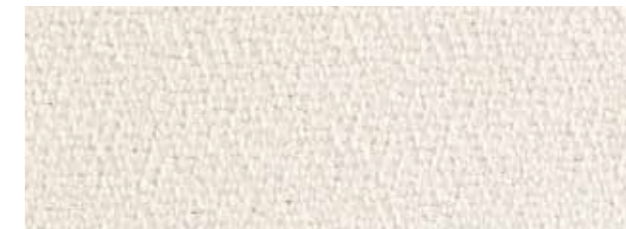

Colour 0001

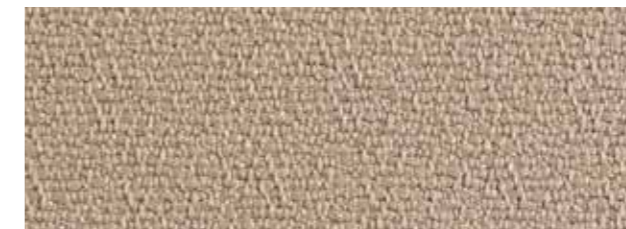

Colour 1008



Colour 2005

# FIBER 12 ECONYL®

## 100% Regenerated nylon

**I**l primo tessuto fonoassorbente realizzato in ECONYL®, materiale nato dalla rigenerazione dei rifiuti di nylon provenienti da tutto il mondo, come reti da pesca o moquette usate. Il nylon rigenerato ECONYL® scelto per dare vita a questo nuovo tessuto acustico è un materiale ecologicamente sostenibile che risponde con un'innovazione responsabile alla crescente domanda di comfort acustico e benessere. Con il processo di rigenerazione ECONYL® si ottiene un materiale rigenerabile all'infinito e con le stesse caratteristiche del nylon standard.

**EN** It is the first sound-absorbing fabric made from ECONYL®, a material created from the regeneration of nylon waste from all over the world, such as fishing nets or used carpets. ECONYL® regenerated nylon was chosen for this new acoustic fabric i an ecologically sustainable material that responds with responsible innovation to the growing demand for acoustic comfort and well-being. With the ECONYL® regeneration process we obtain an infinitely regenerable material with the same characteristics as standard nylon.

**F** Il s'agit du premier tissu phono-absorbant fabriqué en ECONYL®, un matériau né grâce à la régénération des déchets de nylon venant du monde entier, tels que les filets de pêche ou les moquettes utilisées. Le nylon régénéré ECONYL® choisi pour donner vie à ce nouveau tissu acoustique est un matériau écologiquement durable qui répond avec une innovation responsable à la demande croissante de confort acoustique et de bien-être. Avec le processus de régénération ECONYL® on obtient un matériau régénérable à l'infini avec les mêmes caractéristiques que le nylon conventionnel.

**D** Dies ist das erste schallabsorbierende Gewebe aus ECONYL®, einem Material, das aus der Rückgewinnung von Nylonabfällen aus aller Welt, wie Fischernetzen oder gebrauchten Teppichböden, gewonnen wird. Das für die Herstellung dieses neuen Akustikstoffes verwendete regenerierte Nylon ECONYL® ist ein ökologisch nachhaltiges Material, das auf innovative und verantwortungsbewusste Weise der wachsenden Nachfrage nach akustischem Komfort und Wohlbefinden nachkommt. Aus dem ECONYL®-Regenerationsverfahren entsteht ein unendlich regenerierbares Material mit denselben Eigenschaften wie Standard-Nylon.

**E** Es el primer tejido fonoabsorbente realizado con ECONYL®, un material obtenido a través de la regeneración de residuos de nailon procedentes de todo el mundo, como redes de pesca o moquetas usadas. El nailon regenerado ECONYL® seleccionado para crear este nuevo tejido acústico es un material ecosostenible que responde a una innovación responsable ante la creciente demanda de confort acústico y bienestar. Mediante el proceso de regeneración ECONYL® se obtiene un material renovable indefinidamente y que presenta las mismas características del nailon estándar.

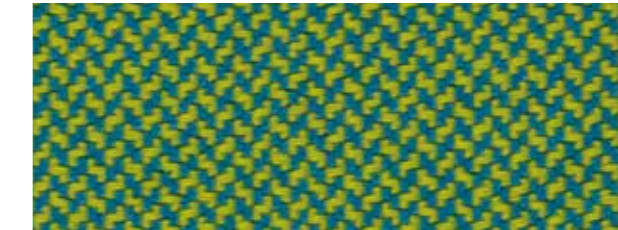
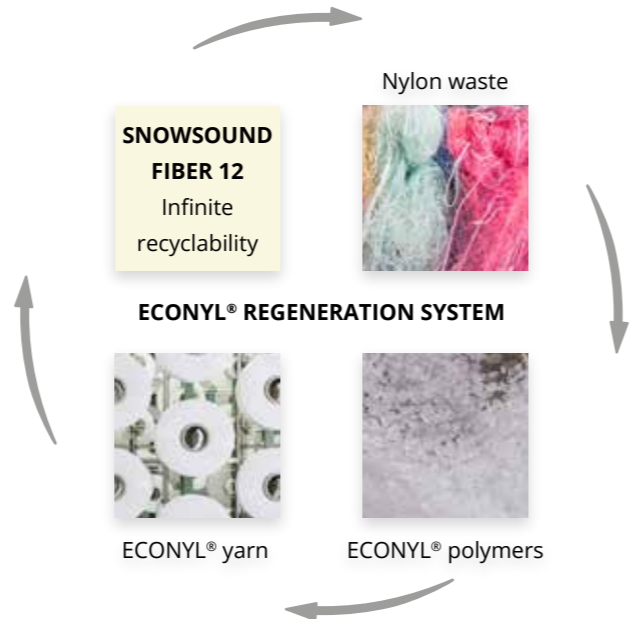

Colour 1200



Colour 1202

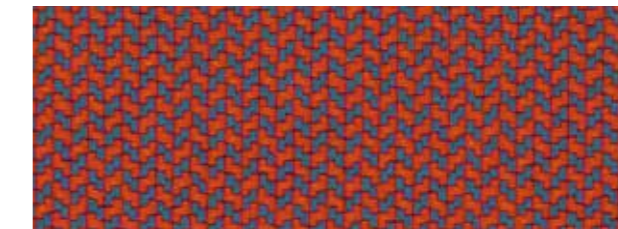

Colour 1201



Colour 1203



Colour 1205



Colour 1204



Watch the video



Clicca e guarda il video.

Click and watch the video.



# Snowsound

## Acoustic products

**I** I prodotti Snowsound consentono di ottenere una correzione acustica in modo semplice e rapido, sia in nuovi ambienti che in quelli esistenti. L'esigenza di vivere e lavorare in ambienti meno rumorosi, riducendo il fastidioso riverbero acustico, trova finalmente una risposta in prodotti innovativi adatti a risolvere svariate esigenze.

**EN** Snowsound products attain acoustic correction easily and quickly, in new areas as well as in existing spaces. The need to live and work in quiet spaces, reducing annoying acoustic reverberation, is finally met with these innovative products, ideal for resolving a variety of needs.

**F** Les produits Snowsound permettent d'obtenir une correction acoustique simplement et rapidement, dans des environnements nouveaux autant que dans des environnements préexistants. Des produits innovants en mesure de satisfaire de multiples exigences, qui répondent enfin au besoin de vivre et de travailler dans des environnements moins bruyants en réduisant la pénible réverbération acoustique.

**D** Snowsound-Produkte ermöglichen eine schnelle und einfache Klangverbesserung in neuen oder schon bestehenden Räumen. Dem Bedürfnis nach einem ruhigeren Lebens- und Arbeitsumfeld wird endlich nachgekommen, indem der nervtötende Nachhall begrenzt wird. Ermöglicht wird dies durch innovative Produkte, die unterschiedlichen Ansprüchen genügen.

**E** Con los productos Snowsound se pueden hacer correcciones acústicas de forma sencilla y rápida, tanto en ambientes nuevos como en los ya existentes. La necesidad de vivir y trabajar en locales con menos ruido, limitando la molesta reverberación acústica, por fin se puede atender con productos novedosos aptos a solucionar las diferentes exigencias.

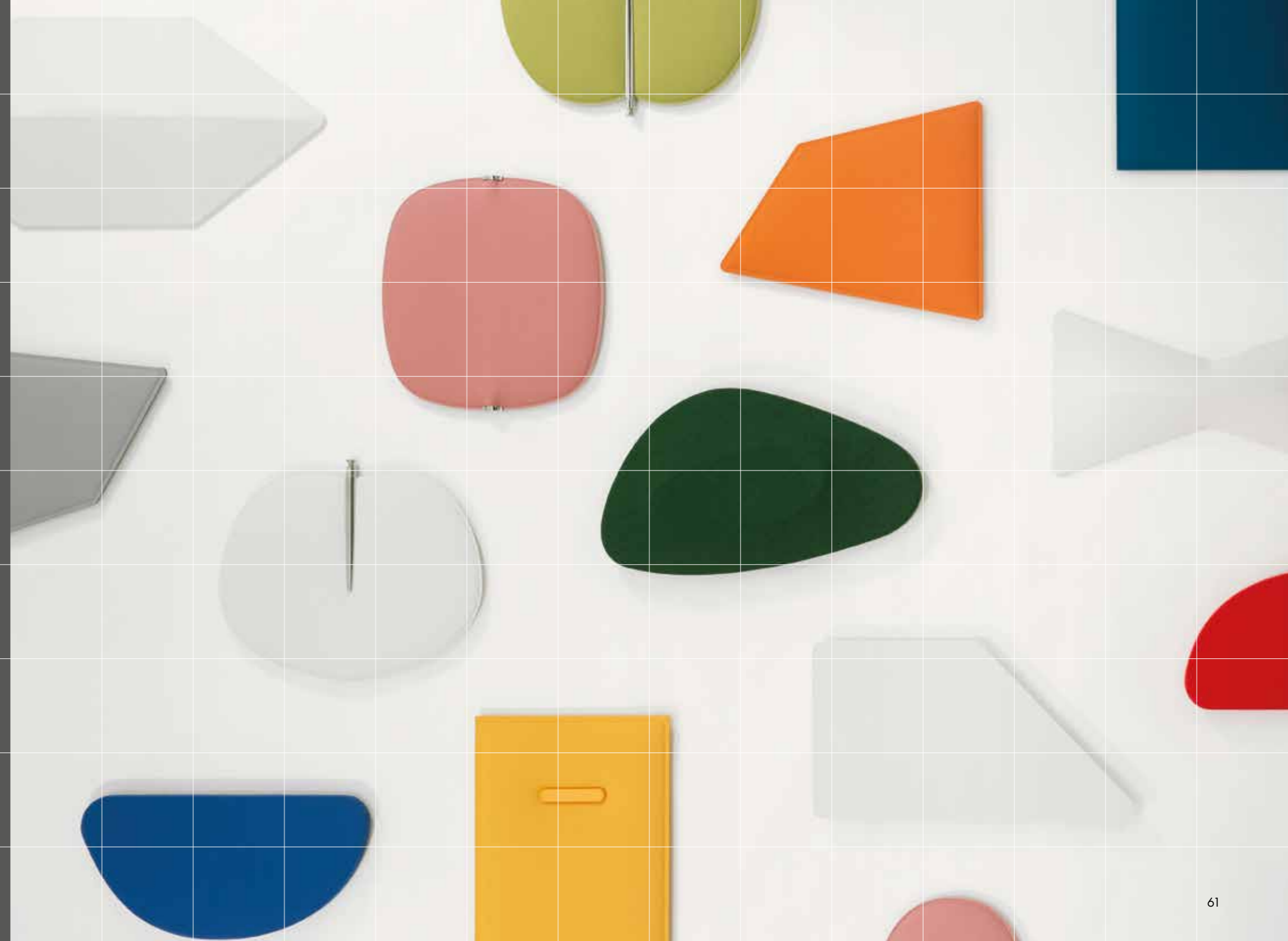

# INTEGRAL

## Bartoli Design



CE

CE

**I**\_Pannelli fonoassorbenti di forma circolare convessa applicabili a parete in aderenza, distanziati di 5 cm, oppure sospesi a soffitto con 3 cavi regolabili in altezza. Possono essere accessoriati con luce led indiretta che aggiunge alla funzione di miglioramento acustico quella di corpo illuminante. Il pannello a parete con luce led crea un effetto di illuminazione wall-washing.

**EN**\_Convex circular sound-absorbing panels that can be attached to the wall, spaced 5 cm apart, or suspended from the ceiling with 3 height-adjustable cables. They can be accessorised with indirect LED light, combining lighting and acoustic functions. The wall panel with LED light creates a wall-washing lighting effect.

**F**\_Panneaux phono-absorbants de forme circulaire convexe à appliquer au mur en adhérence, espacés de 5 cm, ou suspendus au plafond à l'aide de 3 câbles réglables en hauteur. Ils peuvent être équipés d'une lumière LED indirecte, ajoutant à sa fonction primaire d'amélioration acoustique celle d'un luminaire. Le panneau à mur avec lumière LED crée un effet d'éclairage wall-washing.

**D**\_Schallabsorbierende Paneele mit einer runden, konvexen Form, die in einem Abstand von 5 cm an der Wand befestigt oder mit 3 höhenverstellbaren Seilen an der Decke aufgehängt werden können. Sie können mit indirektem LED-Licht ausgestattet werden, wodurch sie nicht nur eine akustische Verbesserung herbeiführen, sondern auch als Leuchtkörper dienen. Das Wandpaneel mit LED-Licht erzeugt einen wandflutenden Beleuchtungseffekt.

**E**\_Paneles fonoabsorbentes de forma redonda y convexa, que pueden ser bien colocados en la pared, adhiriéndose a la misma, a una distancia de 5 cm, o colgados del techo mediante 3 cables regulables en altura. Pueden complementarse con iluminación LED indirecta, sumando así la función de cuerpo luminoso a la de la corrección acústica. El panel de pared con luz LED crea un efecto de iluminación indirecta (wall washing).





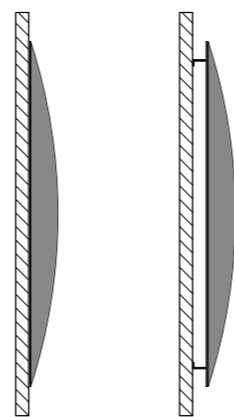
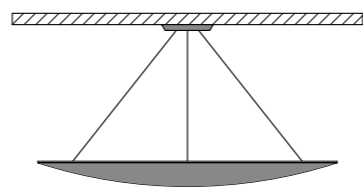
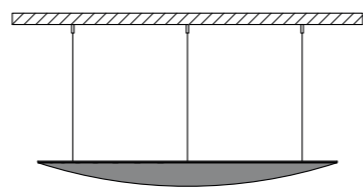
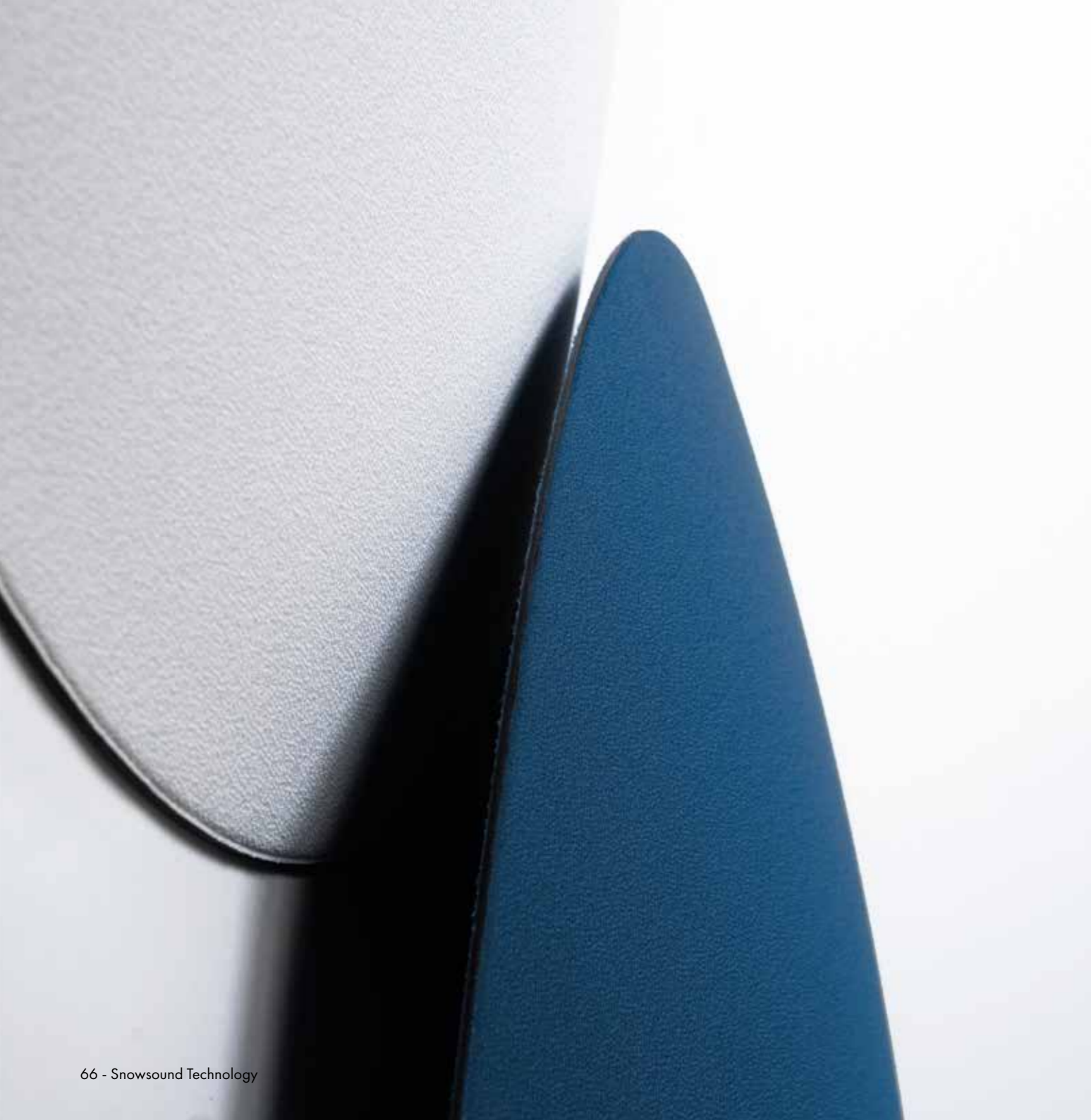

# MILANO

## Caimi Lab



**I** Paralume fonoassorbente di grandi dimensioni, realizzato con tessuto Snowsound Fiber 8 Bouclé, caratterizzato da una struttura in tubolare che tiene il tessuto acustico di rivestimento leggermente sciancrato all'esterno e plissettato all'interno. L'intercapedine d'aria che si crea tra il tessuto esterno e quello interno consente di incrementare le performance acustiche del paralume. Disponibile in due misure; diametro 80 e 120 cm. Il paralume è sospeso a soffitto mediante tre cavi regolabili in altezza.

**EN** Large sound-absorbing lampshade, made with Snowsound Fiber 8 Bouclé fabric, featuring a tubular structure that keeps the acoustic fabric slightly waisted on the outside and pleated on the inside. The air gap created between the external and internal fabric allows and increased acoustic performance of the lampshade. Available in two sizes; diameters 80 and 120 cm. The lampshade is suspended from the ceiling using three height-adjustable cables.

**F** Abat-jour phono-absorbant de grandes dimensions, réalisé avec le tissu Snowsound Fiber 8 Bouclé, caractérisé par une structure tubulaire qui maintient le tissu phono-absorbant légèrement détendu à l'extérieur et plissé à l'intérieur. L'espace d'air qui se crée entre le tissu externe et interne permet d'augmenter les performances acoustiques de l'abat-jour. Disponible en deux tailles; diamètre 80 et 120 cm. L'abat-jour est suspendu au plafond avec trois câbles à hauteur réglable.

**D** Großformatiger, schallabsorbierender Lampenschirm aus Snowsound Fiber 8 Bouclé-Gewebe, der sich durch eine röhrenförmige Struktur auszeichnet, die das akustische Bezugsmaterial auf der Außenseite leicht nach innen gewölbt und auf der Innenseite plissiert hält. Der Hohlraum, der zwischen der äußeren und der inneren Stofflage entsteht, verbessert die akustische Leistung des Lampenschirms. Erhältlich in zwei Größen: Durchmesser 80 und 120 cm. Der Lampenschirm wird mit drei höhenverstellbaren Seilen von der Decke abgehängt.

**E** Lámpara con pantalla fonoabsorbente de gran tamaño realizada con tejido Snowsound Fiber 8 Bouclé. Consta de una estructura tubular que hace que el tejido fonoabsorbente del revestimiento caiga, ciñéndose en la parte exterior y creando un plisado en la interior. El espacio que se crea entre el tejido externo y el interno permite aumentar sus prestaciones acústicas. Disponible en dos medidas: 80 o 120 cm de diámetro. La lámpara puede colgarse del techo mediante tres cables regulables en altura.







**I**\_Il rivestimento in Snowsound Fiber 8 Bouclé è facilmente sfoderabile grazie alle zip che corrono lungo il perimetro superiore.

**EN**\_The Snowsound Fiber 8 Bouclé covering is easily removable thanks to the zips that run along the upper perimeter.

**F**\_Le revêtement en Snowsound Fiber 8 Bouclé s'enlève facilement grâce aux fermetures éclair le long du périmètre supérieur.

**D**\_Der Bezug aus Snowsound Fiber 8 Bouclé ist dank der am oberen Rand verlaufenden Reißverschlüsse leicht abnehmbar.

**E**\_El revestimiento de Snowsound Fiber 8 Bouclé es fácilmente desfundable gracias a las cremalleras ubicadas en el perímetro superior



**I**\_Nel paralume possono essere utilizzati differenti corpi illuminanti.

**EN**\_Different lighting elements can be used in the lampshade.

**F**\_Différents luminaires peuvent être utilisés dans l'abat-jour.

**D**\_Im Lampenschirm können verschiedene Leuchtkörper eingesetzt werden.

**E**\_La lámpara con pantalla es compatible con diferentes cuerpos luminosos.



# SNOWCUSTOM

## Caimi Lab



**A+E** optional  
Info pag. 22



Clicca e vai alla pagina selezionata.

Click and go to the selected page.

**I** Pannelli fonoassorbenti brevettati realizzati in fibre di poliestere a densità variabile rivestiti in tessuto Snowsound Fiber, disponibili nella versione a parete e a soffitto. L'ampia gamma di dimensioni e finiture consente di adattarsi alle diverse esigenze estetiche e architettoniche.

**EN** Both wall and ceiling versions are available of these sound-absorbing panels, which are made of variable-density polyester fibres covered in Snowsound Fiber. A wide range of sizes and finishes means these panels can cater to different aesthetic and architectural needs.

**F** Panneaux phono-absorbants brevetés réalisés en fibres de polyester à densité variable revêtus en tissu Snowsound Fiber, disponibles dans la version pour paroi et pour plafond. Le vaste assortiment des dimensions et finitions permet de s'adapter aux différentes exigences esthétiques et architecturales.

**D** Schallabsorbierende patentierte Paneele aus Polyesterfasern mit variabler Dichte, bezogen mit Snowsound Fiber, erhältlich als Wand- und Deckenversion. Die große Auswahl an Größen und Ausführungen ermöglicht die Anpassung an unterschiedliche ästhetische und bauliche Anforderungen.

**E** Paneles fonoabsorbentes de fibras de poliéster de densidad variable, tapizados con el tejido Snowsound Fiber. Están disponibles en la versión de pared y de techo. Su amplia gama de medidas y acabados les permite adaptarse a cualquier tipo de demanda estética y arquitectónica.



Fiber 3 Melange



Fiber 8 Bouclé



Fiber 0









**I**\_La tecnologia Snowcustom consente di realizzare pannelli fonoassorbenti su misura per adattare le scelte di correzione acustica alle diverse esigenze estetiche e architettoniche dei progetti.

**EN** \_Snowcustom technology allows sound-absorbing panels to be customized in order to meet specific acoustic, aesthetic and architectural requirements in every project.

**F**\_La technologie Snowcustom permet de réaliser des panneaux phono-absorbants sur mesure pour adapter les mesures de correction acoustique aux différentes exigences esthétiques et architecturales du projet.

**D**\_Die Snowcustom-Technologie ermöglicht es, schallabsorbierende Paneele nach Maß zu erstellen, um die akustische Korrektur an die verschiedenen ästhetischen und baulichen Anforderungen des jeweiligen Projekts anzupassen.

**E**\_La tecnología Snowcustom permite realizar paneles fonoabsorbentes a medida para poder adaptar la corrección acústica a las diversas necesidades estéticas y arquitectónicas de cada proyecto.



# CLIMBING

## Raffaello Manzoni



**I**“Climbing è un sistema organico, componibile liberamente, esce dagli schemi della regolarità, è creativo. Legato formalmente e concettualmente a un ambiente naturale, crea superfici uniche, sempre diverse. I volumi, ispirati a ciottoli e pareti in sasso, creano particolari e irregolari giochi di luce e incrementano la performance acustica.”

**EN** Climbing is an organic system, freely combinable, which goes beyond the rules of regularity. Formally and conceptually linked to nature, it creates unique and ever different surfaces. The volumes, inspired by pebbles and stone walls, create a particular and irregular play of light, increasing the acoustic performance.”

**F**“Climbing est un système organique à combiner librement et qui sort du moule de la régularité. Sa forme et sa conception sont liées à l’environnement naturel et créent des surfaces uniques et toujours différentes. Les volumes, qui s’inspirent des galets et des murs en pierre, créent des jeux de lumière particuliers et irréguliers et renforcent le rendement acoustique”.

**D**“Climbing ist ein organisches, frei kombinierbares System, das aus der Regelmäßigkeit ausbricht. Durch seine formale und konzeptionelle Nähe zur natürlichen Umwelt entstehen einzigartige, stets unterschiedliche Oberflächen. Die an Kieselsteine und Steinmauern angelehnten Formgebung erzeugt besondere, unregelmäßige Lichtspiele und verbessert die akustische Leistung.”

**E**“Climbing es un sistema orgánico, libremente combinable, alejado de los patrones tradicionales de uniformidad. Vinculado tanto a nivel formal como conceptual a un entorno natural, logra crear superficies únicas, siempre diferentes. Sus volúmenes –inspirados en guijarros de río y paredes de piedra-, crean peculiares e irregulares juegos de luz, logrando así incrementar sus prestaciones acústicas.”

(Raffaello Manzoni)





**I**\_Pannelli fonoassorbenti a parete, in tre differenti forme, realizzati con tecnologia Snowcustom. Fissaggio a parete tramite attacchi magnetici.

**EN**\_Wall-mounted acoustic panels in three different shapes, using Snowcustom technology. Wall mounted through magnets.

**F**\_Panneaux phono-absorbants pour paroi, de trois formes différentes, produits avec la technologie Snowcustom. Montage mural au moyen d'attaches magnétiques.

**D**\_Schallabsorbierende Wandpaneele in drei unterschiedlichen Formen, hergestellt mit Snowcustom-Technologie. Wandbefestigung durch magnetische Halterungen.

**E**\_Paneles fonoabsorbentes de pared en tres formas diferentes, realizados con tecnología Snowcustom. Se colocan en la pared mediante anclajes imantados.



## TRI BU

Paola Navone - Otto Studio



**I** "Quattro elementi fonoassorbenti colorati, dalle forme geometriche, compongono sulle pareti grandi maschere silenziose dall'immagine un po' tribale e un po' pop. Come in una curiosa performance teatrale dialogano tra loro divertendosi a catturare suoni e rumori."

**EN** "Four coloured sound-absorbing elements with geometric shapes create large silent masks on the walls with a somewhat tribal and pop image at the same time. As in a curious theatrical performance, they talk to each other while having fun capturing sounds and noises."

**F** "Quatre éléments phono-absorbants colorés, qui composent sur les parois de grands masques silencieux à l'aspect un peu tribal et légèrement pop. Comme dans une pièce de théâtre d'avant-garde, ces éléments dialoguent entre eux en s'amusant à capter les sons et les bruits".

**D** "Vier farbige schallabsorbierende Elemente bilden an den Wänden große, stille Masken von leicht tribalem und leicht poppigem Aussehen. Wie in einem kuriosen Schauspiel führen sie einen Dialog miteinander und vergnügen sich damit, Klänge und Geräusche einzufangen."

**E** "Cuatro elementos fonoabsorbentes de colores crean sobre las paredes grandes máscaras silenciosas que aúnan inspiración tribal y estética pop. Como en una original performance teatral, parecen dialogar entre ellas, jugando a capturar sonidos y ruidos."

(Paola Navone)





**I** Pannelli fonoassorbenti a parete, realizzati con tecnologia Snowcustom. Tri Bu si compone di quattro elementi che si possono combinare tra di loro, dando vita a diverse composizioni. Fissaggio a parete tramite attacchi magnetici.

**EN** Wall-mounted acoustic panels with Snowcustom technology. Tri Bu consists of four panels that can be fixed to walls in different configurations. Wall mounted through magnets.

**F** Panneaux phono-absorbants pour paroi, produit avec la technologie Snowcustom. Tri Bu est composé de quatre éléments qui peuvent être combinés entre eux, pour créer différentes compositions. Montage mural au moyen d'attaches magnétiques.

**D** Schallabsorbierende Wandpaneele, hergestellt mit Snowcustom-Technologie. Tri Bu besteht aus vier Elementen, die miteinander kombiniert werden können und somit verschiedene Kompositionen ermöglichen. Wandbefestigung durch magnetische Halterungen.

**E** Paneles fonoabsorbentes para pared realizados con tecnología Snowcustom. Tri Bu consta de cuatro elementos combinables entre sí que permiten crear distintas composiciones. Se colocan en la pared mediante anclajes imantados.

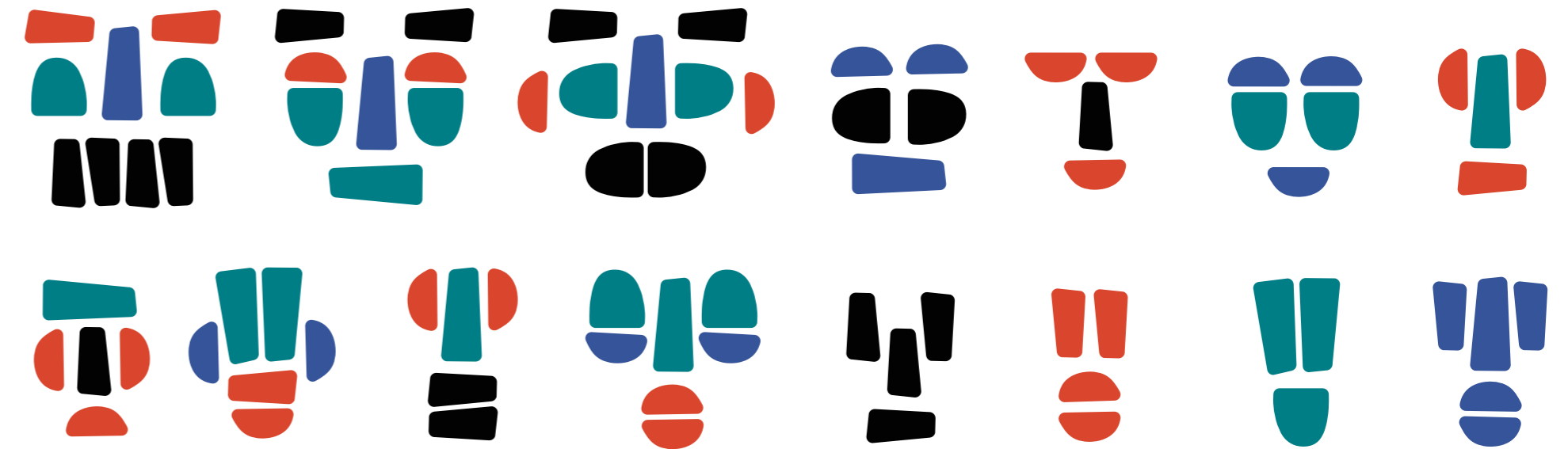

# SNOWGEMS

(a+b) Dominoni, Quaquaro



CE



**I** Sistema fonoassorbente modulare, composto da pannelli con forme e colori ispirati alle gemme preziose, realizzati con tecnologia Snowsound. Snowgems è un sistema componibile che genera soluzioni in grado di influire sulla qualità acustica ed estetica degli ambienti. I pannelli sono disponibili in 4 formati e possono essere abbinati a strutture freestanding, a parete e a soffitto.

**EN** Modular sound-absorbing system, composed of panels in shapes and colours reminiscent of precious gems; made with Snowsound technology. Snowgems is a scalable modular solution for the enhancement of both the acoustic and the aesthetic quality of a space. The panels come in 4 sizes and can be attached to freestanding structures, walls, and ceilings.

**F** Système phono-absorbant modulaire, comprenant des panneaux aux formes et couleurs qui s'inspirent des pierres précieuses, réalisés avec la technologie Snowsound. Snowgems est un système modulaire, qui crée des solutions permettant d'améliorer la qualité acoustique et esthétique des intérieurs. Les panneaux sont disponibles en 4 formats et peuvent être associés à des structures autoportantes, à paroi ou au plafond.

**D** Modulares Schallabsorptionssystem aus Paneelen, deren Formen und Farben Edelsteinen nachempfunden sind, hergestellt mit Snowsound-Technologie. Snowgems ist ein modulares System, das zu Lösungen zusammengesetzt werden kann, die die akustische und ästhetische Raumqualität beeinflussen. Die Paneele sind in 4 Formaten erhältlich und können mit freistehenden sowie mit Wand- und Deckenstrukturen kombiniert werden.

**E** Sistema fonoabsorbente modular. Consta de paneles con formas y colores inspirados en las piedras preciosas y realizados aplicando la tecnología Snowsound. Snowgems es un sistema componible que da vida a soluciones capaces de influir en la calidad acústica y estética de los espacios. Los paneles están disponibles en 4 formatos y se pueden combinar con estructuras que permiten su colocación tanto en pared como en techo.





**I**\_Tutto nasce dal gesto di infilare una serie di gemme colorate di forme diverse su un filo per creare gioielli preziosi, collane e orecchini pendenti. Snowgems è un sistema aperto che genera morbide soluzioni formali in grado di incidere sensibilmente sulla qualità acustica ed estetica degli ambienti.

**EN**\_The design of these units is inspired by the idea of a thread of differently shaped and coloured precious gems strung together to form a necklace or pendant earrings. Snowgems is a scalable modular system based on units that add both formality and softness to a space and significantly enhance its acoustic and aesthetic quality.

**F**\_Tout vient de l'acte d'enfiler une série de pierres précieuses colorées de différentes formes sur un fil pour créer des bijoux précieux, des colliers et des boucles d'oreilles avec pendentif. Snowgems est un système ouvert, qui crée des solutions aux formes souples en mesure d'améliorer la qualité acoustique et esthétique des intérieurs.

**D**\_Die Grundidee war die Geste des Auffädels einer Reihe von farbigen, unterschiedlich geformten Edelsteinen auf einen Draht, um kostbaren Schmuck, Halsketten und Ohrhänger zu schaffen. Snowgems ist ein offenes System, das weiche formale Lösungen erzeugt, die die akustische und ästhetische Raumqualität erheblich beeinflussen können.

**E**\_Todo nace del gesto de enhebrar una serie de piedras de diferentes colores y formas en un hilo para crear joyas preciosas, collares y pendientes. Snowgems es un sistema abierto que da vida a soluciones con formas delicadas, capaces de influir notablemente en la calidad acústica y estética de los espacios.







## BOW King & Miranda



CE

**I** Sistema di elementi fonoassorbenti modulari e componibili, ispirati dalle forme degli scafi delle navi. I due elementi, realizzati con tecnologia Snowsound, assumono una configurazione tridimensionale che genera un'intercapedine di aria tra il pannello e la parete aumentando le prestazioni acustiche. Gli elementi vengono fissati a parete e a soffitto tramite particolari attacchi in metallo e magneti che rendono i pannelli facilmente posizionabili e rimovibili. Gli attacchi a soffitto sono dotati di cavi di sicurezza. La dimensione della piastra d'attacco permette di correggere in fase di installazione la posizione dei pannelli.

**EN** A system of scalable, modular, sound-absorbing elements, inspired by the shapes of boat bows and hulls. The two elements, made with Snowsound technology, are arranged on a three-dimensional plane that leaves room for an air gap between the panel and the wall, which improves acoustic performance. The elements attach to the wall or ceiling by means of special metal attachments and magnets, which makes them easy to reposition and remove. The ceiling attachments come complete with safety cables. As the metal strips used to mount the panels come in different sizes, it is possible to reposition the panels during installation to achieve the effect desired.

**F** Système d'éléments phono-absorbants modulaires inspiré de la forme des coques de bateaux. Les deux éléments, réalisés avec la technologie Snowsound, donnent lieu à une configuration tridimensionnelle qui génère une lame d'air entre le panneau et le mur, augmentant ainsi les performances acoustiques. Les éléments sont fixés au mur et au plafond au moyen d'attaches métalliques spéciales et d'aimants qui permettent de positionner et de retirer facilement les panneaux. Les attaches pour plafond sont munies de câbles de sécurité. La dimension de la plaque de l'attache permet de corriger la position des panneaux pendant l'installation.

**D** Ein System aus modularen, schallabsorbierenden Elementen, die an die Form eines Schiffsrumpfs erinnern. Die beiden mit Snowsound-Technologie hergestellten Elemente besitzen eine dreidimensionale Konfiguration, die einen Luftraum zwischen dem Paneel und der Wand erzeugt und somit die akustische Leistung erhöht. Die Elemente werden mit speziellen Metallbefestigungen und Magneten an der Wand und der Decke befestigt, so dass sich die Paneele leicht anbringen und entfernen lassen. Die Deckenbefestigungen sind mit Sicherheitsseilen ausgestattet. Die Größe der Montageplatte ermöglicht eine Korrektur der Paneelposition während der Installation.

**E** Sistema de elementos fonoabsorbentes modulares y componibles, que se inspiran en las formas de los cascos de las embarcaciones. Ambos elementos están desarrollados aplicando la tecnología Snowsound y adquieren una configuración tridimensional. Esto crea una cámara de aire entre el panel y la pared incrementando, así, sus prestaciones acústicas. Los elementos se sujetan, ya sea a la pared o al techo, mediante unos anclajes particulares, metálicos e imantados, que facilitan el posicionamiento y la extracción de los paneles. Los anclajes de techo poseen cables de seguridad. El tamaño de la placa de anclaje permite corregir la posición de los paneles durante la instalación.

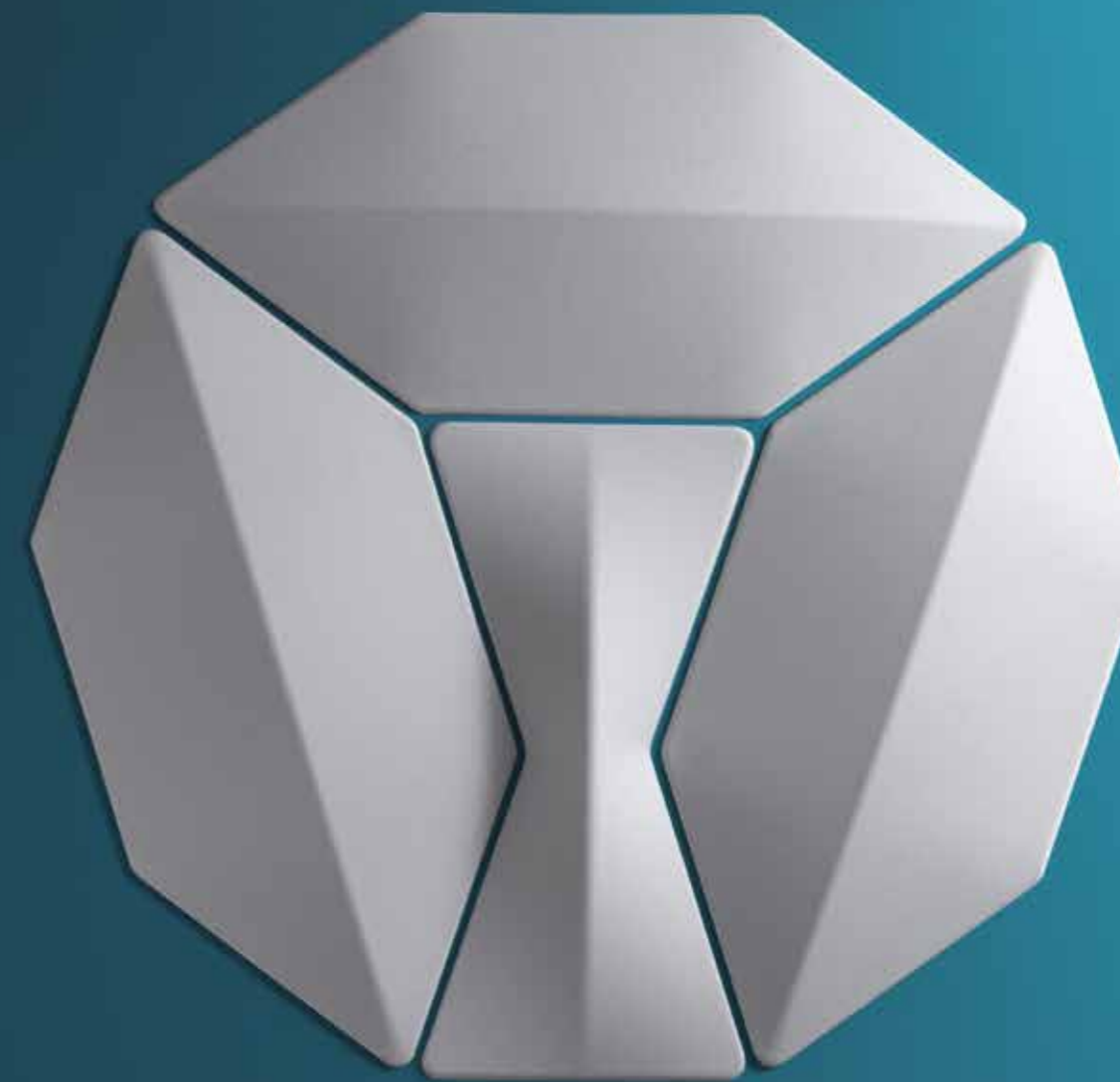





**I**\_Le due sagome sono componibili e possono generare svariate composizioni. La tridimensionalità dei pannelli, oltre ad aumentare le performance acustiche, crea interessanti bassorilievi e giochi di luce.

**EN**\_The two elements are modular and can be combined to form various different compositions. In addition to improving acoustic performance, the three-dimensionality of the panels makes for an impressive bas-relief effect and plays interestingly with the effects of light and shadow.

**F**\_Les deux formes sont modulaires et permettent de créer différents types de composition. La tridimensionnalité des panneaux améliore non seulement les performances acoustiques, mais crée également des bas-reliefs et des effets de lumière intéressants.

**D**\_Die beiden Formen sind modular und können zu einer Vielzahl an Kompositionen zusammengesetzt werden. Die Dreidimensionalität der Paneele erhöht nicht nur die akustische Leistung, sondern erzeugt auch interessante Flachreliefs und Lichtspiele.

**E**\_Los dos perfiles son componibles y pueden dar vida a combinaciones variadas. La tridimensionalidad de los paneles no solo aumenta las prestaciones acústicas, sino que además crea interesantes bajorrelieves y juegos de luz.



# BOTANICA

## Mario Trimarchi



CE

**I**\_Il sistema di elementi fonoassorbenti Botanica è composto da un pannello a forma di foglia trattenuto da un supporto in metallo cromato che può essere fissato con diverse inclinazioni e proposto in abbinamento con differenti strutture portanti.

**EN**\_The system of sound absorbing elements Botanica is composed of a leaf shaped panel held by a chromed metal support that can be fixed with different inclinations and proposed in combination with different bearing structures.

**F**\_Le système des phono-absorbants Botanica comprend un panneau en forme de feuille posé sur un support en métal chromé, qui peut être fixé avec des inclinaisons différentes et proposé en association avec différentes structures portantes.

**D**\_Botanica besteht aus blattförmigen Schalldämm-Elementen, die an einer verchromten Halterung montiert werden. Diese können mit verschiedenen Neigungen fixiert werden und mit verschiedenen Tragstrukturen kombiniert werden.

**E**\_El sistema de elementos fonoabsorbentes Botanica está compuesto por un panel en forma de hoja sujeto por un soporte en metal cromado que puede fijarse con distintas inclinaciones y se propone en combinación con distintas estructuras de soporte.



Residential building, Chicago (U.S.A.)





**I**\_Telaio componibile in lunghezza per il posizionamento a parete o a soffitto realizzato in tubolare di acciaio cromato caratterizzato dalla curvatura 3D del tubo.

**EN**\_Modular frame that combines lengthwise for wall installation or ceiling mounting, fabricated in chrome-plated tubular steel, characterized by a 3D curvature of the tube.

**F**\_Un cadre à longueur modulable, pour le positionnement sur la paroi ou le plafond réalisé en tubes d'acier chromé caractérisé par la courbure 3D du tube.

**D**\_Das Gerüst kann der Länge nach an einer Befestigung an der Wand oder an der Decke angepasst werden und ist aus dreidimensionalen, verchromtem Stahlrohr hergestellt.

**E**\_Estructura de longitud modulable destinada a fijarse en la pared o el techo, realizada en tubular de acero cromado caracterizada por la curvatura tridimensional del tubo.

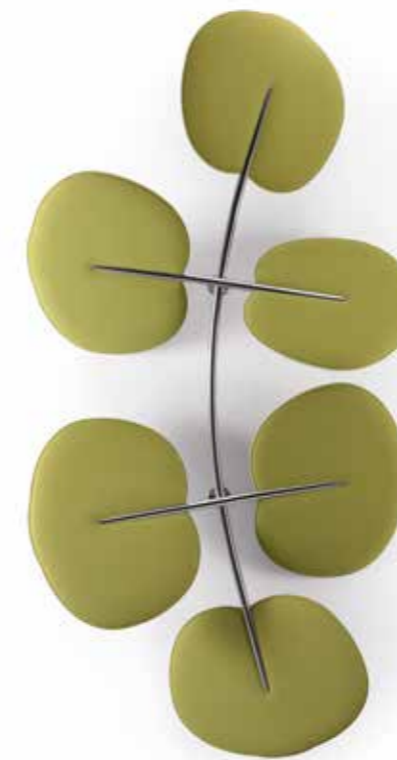



**I**\_Il pannello, nella versione singola, può essere fissato a parete/soffitto tramite un supporto in metallo cromato.

**EN**\_The panel, in the single version, can be anchored to the wall/ceiling with the chrome-plated metal bracket.

**F**\_Dans la version individuelle, le panneau peut être fixé à la paroi/plafond avec un support en métal chromé.

**D**\_Das Einzelpaneel kann mit einer verchromten Metallhalterung an der Wand/Decke angebracht werden.

**E**\_En la versión individual, el panel puede fijarse a la pared/techo mediante un soporte en metal cromado.



**I**\_Nella versione freestanding, i pannelli sono sostenuti da una struttura in tubolare cromato con base in acciaio verniciato.

**EN**\_In the freestanding version, the panels are supported by a chrome-plated tubular frame with a powder coated steel base.

**F**\_Dans la version autoportante, les panneaux sont soutenus par une structure en tube chromé avec une base en acier peint.

**D**\_In der freistehenden Version sind die Paneele an einem verchromten Stahlständer mit einem Sockel aus pulverbeschichteten Stahl befestigt.

**E**\_En la versión con soporte autónomo, los paneles se sujetan a una estructura en tubular cromado con base en acero barnizado.



## CLASP RING (a+b) Dominoni, Quaquaro



**I** Elementi fonoassorbenti di forma circolare realizzati con tessuti Snowsound Fiber. La struttura, realizzata in tubolare di acciaio cromato, è sospesa su cavi dotati di sistema di regolazione dell'altezza.

**EN** Circular-shaped sound-absorbing elements made with Snowsound Fiber fabrics. The structure, which consists of a chromed tubular steel frame, is suspended from height-adjustable cables.

**F** Des éléments phono-absorbants en forme circulaire réalisés avec le tissu Snowsound Fiber. La structure en tubes d'acier chromé est suspendue à des câbles munis d'un système pour régler la hauteur.

**D** Kreisförmige schallabsorbierende Elemente aus Snowsound Fiber Gewebe. Die aus verchromtem Stahlrohr bestehende Struktur ist an höhenverstellbaren Seilen aufgehängt.

**E** Elementos fonoabsorbentes de forma circular, realizados con los tejidos Snowsound Fiber. La estructura se construye mediante un elemento tubular de acero cromado y cuelga de unos cables que poseen un sistema de regulación de la altura.







**I**\_Clasp Ring offre la possibilità di inserire lampade all'interno.

**EN**\_A Clasp Ring can be embedded with a light fixture.

**F**\_Clasp Ring offre la possibilità d'ajouter des lampes à l'intérieur.

**D**\_Clasp Ring bietet die Möglichkeit, Lampen im Inneren zu installieren.

**E**\_Clasp Ring ofrece la posibilidad de instalar lámparas en su interior.



## CLASP DIVIDER (a+b) Dominoni, Quaquaro



**I**\_In Clasp divider il tessuto acustico Snowsound Fiber è posto su una struttura componibile realizzata in metallo cromato sospesa su cavi con sistema di regolazione dell'altezza. Grazie ai giunti in metallo la struttura è liberamente configurabile e consente di creare infinite composizioni. Il sistema è sfoderabile.

**EN**\_In Clasp divider, the acoustic fabric Snowsound Fiber is placed on a modular structure made of chromed metal suspended on cables with a height adjustment system. Thanks to the metal joints the structure is freely configurable and allows infinite compositions. The fabric slipcover is removable.

**F**\_Pour Clasp divider le tissu acoustique Snowsound Fiber enveloppe une structure modulaire réalisée en métal chromé suspendue à des câbles avec un système de réglage de la hauteur. Grâce aux joints en métal, la structure peut être librement configurée et permet de créer une infinité de compositions. Le tissu est amovible.

**D**\_In Clasp divider bedeckt der Schalldämmstoff Snowsound Fiber eine nach Bedarf zusammensetzbaren Halterung aus verchromtem Metall, welche an höhenverstellbaren Seilen befestigt ist. Dank Metallgelenkkupplungen kann die Struktur frei konfiguriert und in unendlichen Formen komponiert werden. Das System ist abziehbar.

**E**\_En Clasp divider el tejido acústico Snowsound Fiber se dispone sobre una estructura modulable realizada en metal cromado y suspendida mediante cables con un sistema de regulación de la altura. Gracias a las juntas de metal, la estructura se puede configurar libremente y permite crear composiciones infinitas. El sistema es desenfundable.



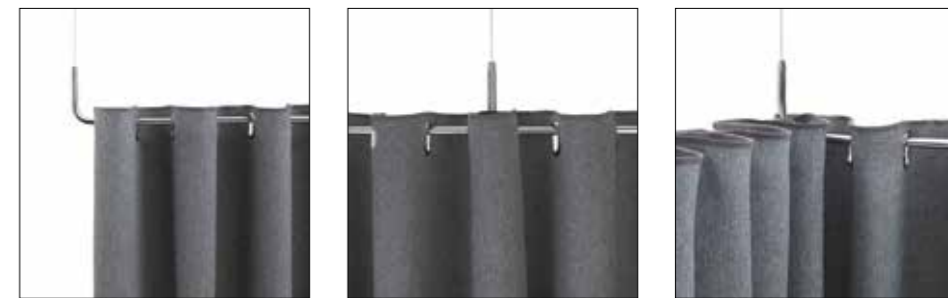
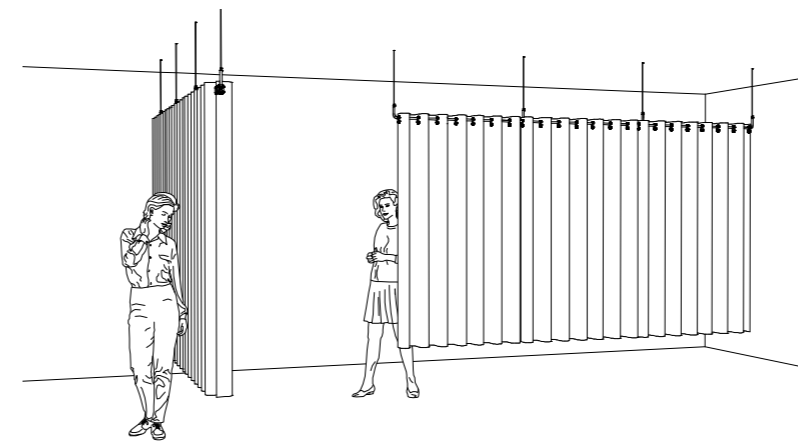
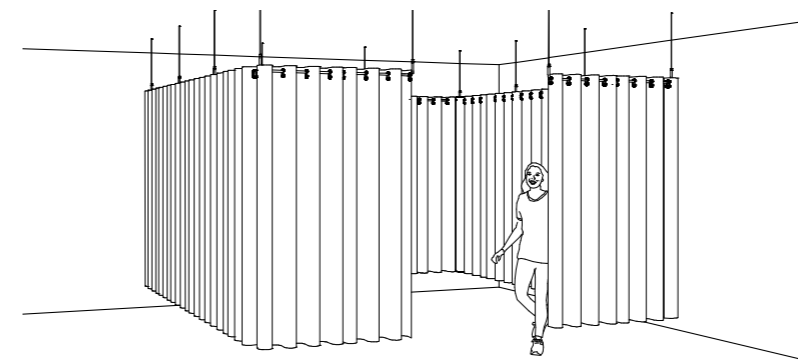

# SEPÀ | SEPÀ ROLLS

## Sezgin Aksu



**I**\_Divisori fonoassorbenti realizzati con tessuti Snowsound Fiber e strutture in tubolare di acciaio cromato montate su basi piatte in metallo verniciato oppure su una sola base in tubolare dotata di ruote poste alle estremità che ne consentono il facile spostamento. Il sistema è sfoderabile.

**EN**\_Sound absorbing dividers made with Snowsound Fiber fabrics and chromed tubular steel structures mounted on a single tubular base that allows you to juxtapose several dividers in line or creating a corner. The tubular base is equipped with wheels located at the ends that allow easy movement. The fabric slipcover is removable.

**F**\_Cloisons phono-absorbants réalisées en tissu Snowsound Fiber et structures en tube d'acier chromé montées sur une base unique plate en tubes que permet de disposer plusieurs cloisons en ligne droite ou en angle, la base en tube est munie de roulettes aux extrémités qui permettent un déplacement facile. Le tissu est amovible.

**D**\_Schalldämmende Trennwände aus Snowsound-Fiber-Stoffen und Halterungen aus verchromtem Stahlrohr, auf einem einzigen Stahlrohr-Sockel montiert, durch den mehrere Trennwände der Länge nach oder im Winkel aneinandergereiht werden können. Der Sockel aus Stahlrohr ist mit Rädern versehen, die eine einfache Verstellbarkeit erlauben. Das System ist abziehbar.

**E**\_Mamparas divisorias fonoabsorbentes realizadas con tejidos Snowsound Fiber y estructuras en tubular de acero cromado montadas sobre una única base en tubular que permite alinear varios divisorios o colocarlos formando un ángulo. La base en tubular dispone de ruedas ubicadas en los extremos por lo que es posible desplazarla fácilmente. El sistema es desenfundable.



Sepà



Sepà rolls





**I**\_Sepà rolls permette di accostare più divisori in linea o ad angolo.

**EN**\_Sepà rolls allows you to juxtapose several dividers in line or creating a corner.

**F**\_Sepà rolls permet de disposer plusieurs cloisons en ligne droite ou en angle.

**D**\_Mit Sepà rolls können Sie mehrere Trennwände in Reihe oder an einer Ecke kombinieren.

**E**\_Sepà rolls permite alinear varios divisorios o colocarlos formando un ángulo.



## PLI OVER

Marc Sadler



**I** I divisori Pli Over, realizzati con tecnologia Snowsound, sono disponibili nelle versioni con basi autoportanti o con basi dotate di ruote che consentono grande flessibilità di spostamento nello spazio.

**EN** The Pli Over partitions, made with Snowsound technology, are available in the self-supporting versions or with bases fitted with casters to allow utmost flexibility in moving through the space.

**F** Les cloisons Pli Over, réalisés avec la technologie Snowsound, existent en plusieurs versions, avec bases autoportantes ou bases munies de roues permettant une grande flexibilité des déplacements.

**D** Die mit Snowsound-Technologie ausgestatteten Pli Over Trennwände sind in verschiedenen selbsttragenden Versionen oder mit Sockeln auf Rädern für größere Flexibilität und mühelose Verstellbarkeit im Raum verfügbar.

**E** Las mamparas divisorias Pli Over, realizadas con tecnología Snowsound, están disponibles en dos versiones: una con base de soporte autónomo, y la otra con base dotada de ruedas que permiten una gran flexibilidad de desplazamiento en el espacio.



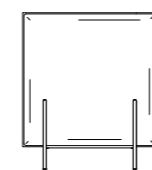
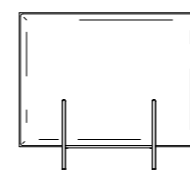
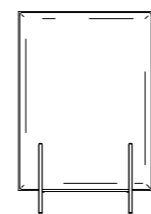

## PLI OVERSIZE

Marc Sadler



**I**\_Pli Oversize è un pannello fonoassorbente realizzato con tecnologia Snowsound, sorretto da un cavalletto in acciaio, può essere utilizzato come divisorio all'interno degli ambienti.

**EN**\_Pli Oversize is a sound-absorbing Snowsound panel, supported by a steel frame which can be used as a partition to divide space.

**F**\_Pli Oversize est un cloison phono-absorbant composé de panneaux Snowsound, soutenu par un chevalet en acier. Elle peut servir de cloison à l'intérieur des pièces.

**D**\_Pli Oversize ist ein schallabsorbierender Raumteiler, der aus Snowsound-Paneelen besteht und von Standfüßen aus Stahl gestützt wird. Das Produkt kann auch als Trennwand eingesetzt werden.

**E**\_Pli Oversize es una mampara fonoabsorbente que está compuesta por paneles Snowsound, sobre un caballete de acero y que se puede emplear como divisorio dentro de diferentes ambientes.







**I** È possibile unire più pannelli tra loro mediante una cinghia che abbraccia il pannello, dotata di bottoni in acciaio ed occhielli che permettono di ottenere soluzioni lineari, soluzioni a "T", ad "L" o ad "X".

**EN** Several panels can be connected together by a strap, fitted with steel buttons and buttonholes, which wrap around the panel and create linear, "T", "L" or "X" formations.

**F** Il est possible d'unir les panneaux entre eux à l'aide d'une courroie qui englobe le panneau, munie de boutons en acier et de boutonnières permettant d'obtenir des solutions linéaires, des solutions en forme de "T", de "L" ou de "X".

**D** Der Riemen umgibt das Paneel und ist mit Stahlknöpfen und Ösen ausgestattet, dank denen lineare Lösungen, sowie "T"-, "L"- oder "X"-förmige Kombinationen realisiert werden können.

**E** Los paneles se pueden acoplar mediante una correa que los rodea y que lleva botones de acero y ojales para formar soluciones planas, soluciones en "T", en "L" o en "X".



## PLI

Marc Sadler



**I**\_Pli è un divisorio fonoassorbente composto da pannelli Snowsound, uniti tra loro mediante una cinghia elastica. La cinghia abbraccia il pannello ed è dotata di bottoni in acciaio ed occhielli che permettono di ottenere soluzioni lineari, soluzioni a "T", ad "L" o ad "X".

**EN**\_Pli is a sound-absorbing partition wall, made up of Snowsound panels joined with elastic bands. The bands embrace the panel and are furnished with steel buttons and O-rings that create linear, "T", "L" or "X" configurations.

**F**\_Pli est un cloison phono-absorbant composé de panneaux Snowsound, unis entre eux par une sangle élastique. La sangle entoure le panneau et elle est munie de boutons en acier et d'œillets qui permettent d'obtenir des solutions linéaires, des solutions en "T", en "L" ou en "X".

**D**\_Pli ist eine schallabsorbierende Trennwand, die aus Snowsound-Paneelen besteht, welche durch elastische Gurte miteinander verbunden werden. Die Gurte umschließen das Paneel und sind mit Stahlknöpfen und Ösen ausgestattet, dank denen lineare Lösungen, "T", "L"- oder "X"-förmige Kombinationen realisiert werden können.

**E**\_Pli es una mampara fonoabsorbente compuesta por paneles Snowsound, enlazados por una correa elástica. La correa rodea el panel y lleva botones de acero y ojales para formar soluciones planas, soluciones en "T", en "L" o en "X".



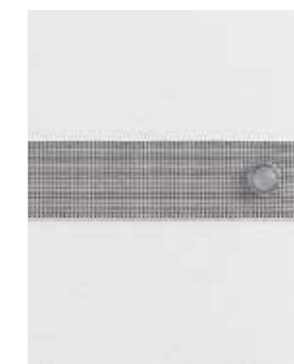

**I**\_Pli offre una grande varietà di colori sia per i pannelli che per le cinghie in tessuto, combinabili tra di loro. Il sistema Pli può essere corredato da una base di sostegno in acciaio cromato.

**EN**\_Pli offers a large variety of colours for the panels and the fabric bands, to mix and match. The Pli system can be furnished with a chrome-plated steel supporting base.

**F**\_Pli offre une grande palette de coloris aussi bien pour les panneaux que pour les sangles en tissu, permettant ainsi de les combiner. Le système Pli peut être équipé d'une base de soutien en acier chromé.

**D**\_Pli bietet eine große Auswahl an Farben, sowohl bei den Paneelen als auch bei den Gurten, die sich gut miteinander kombinieren lassen. Das Pli-System kann außerdem mit Standfüßen aus verchromtem Stahl ausgestattet werden.

**E**\_Pli ofrece un extensa gama de colores tanto para los paneles como para las correas de tela, para poderlos combinar. Se puede dotar al sistema Pli de una base de apoyo de acero cromado.



# SNOWFIX | SNOWMAGNET

## Caimi Lab



**I** I pannelli fonoassorbenti realizzati con tecnologia Snowsound, disponibili in molteplici formati e colori, possono essere fissati a parete con diversi sistemi di aggancio per risolvere le differenti esigenze di utilizzo.

**EN** Acoustic panels using Snowsound technology, available in a wide range of shapes, sizes and colours. Designed to be fixed to walls in a variety of ways in order to suit different requirements.

**F** Les panneaux phono-absorbants réalisés avec la technologie Snowsound, disponibles dans une variété de formats et de couleurs, peuvent être montés au mur avec différents systèmes d'attaches pour répondre aux multiples exigences d'utilisation.

**D** Die mit Snowsound-Technologie hergestellten schallabsorbierenden Paneele sind in verschiedenen Formaten und Farben erhältlich und können je nach Nutzungsanforderungen mit unterschiedlichen Befestigungssystemen an der Wand montiert werden.

**E** Los paneles fonoabsorbentes realizados con tecnología Snowsound, disponibles en múltiples formas y colores, se pueden colocar en las paredes utilizando diferentes sistemas de sujeción, respondiendo a las distintas necesidades de uso.





**I** I pannelli Snowsound possono essere fissati a parete con diversi sistemi di aggancio fissi, mobili o magnetici.

**EN** Snowsound panels can be fixed to the wall with different fixed, mobile or magnetic elements.

**F** Les panneaux Snowsound peuvent être appliqués au mur avec différents systèmes d'accrochage fixes, mobiles ou magnétiques.

**D** Snowsound-Paneele können mit verschiedenen festen, beweglichen oder magnetischen Befestigungssystemen an der Wand angebracht werden.

**E** Los paneles Snowsound pueden ser colocados en la pared utilizando diversos sistemas de anclaje fijos, móviles o magnéticos.





BPER Banca, Modena (Italy)



Auriga, Bari (Italy)

Alur showroom, Merchandise Mart, Chicago (USA)



# SNOWSOUND CEILING

## Caimi Lab



**I** I pannelli fonoassorbenti realizzati con tecnologia Snowsound, disponibili in molteplici formati e colori, possono essere sospesi a soffitto con diversi sistemi di aggancio per risolvere le differenti esigenze di utilizzo.

**EN** Acoustic panels using Snowsound technology, available in a wide range of shapes, sizes and colours. The panels can be suspended from the ceiling in different ways in order to suit different requirements.

**F** Les panneaux phono-absorbants réalisés avec la technologie Snowsound, disponibles dans une variété de formats et de couleurs, peuvent être suspendus au plafond avec différents systèmes de fixation pour répondre aux exigences d'utilisation.

**D** Die mit Snowsound-Technologie hergestellten schallabsorbierenden Paneele sind in verschiedenen Formaten und Farben erhältlich und können je nach Nutzungsanforderungen mit unterschiedlichen Befestigungssystemen an der Decke montiert werden.

**E** Los paneles fonoabsorbentes realizados con tecnología Snowsound, disponibles en una amplia variedad de formas y colores, pueden suspenderse del techo utilizando distintos sistemas de sujeción, respondiendo a diferentes necesidades de uso.









Artisa Architettura, Lamone (Switzerland)



Medtronic Italia, Milano (Italy)



Auditorium, Hamburg (Germany)

# OVERSIZE LUX

Marc Sadler



**I**\_Oversize lux è un progetto che fonde il concetto d'illuminazione tecnica con la tecnologia fonoassorbente Snowsound. Dall'integrazione di questi aspetti sono nati dei veri e propri componenti architettonici, di grandi dimensioni, con luci LED incassate nei pannelli fonoassorbenti. I cavi di sospensione a soffitto sono regolabili.

**EN**\_Oversize lux is a project that brings together the concept of technical lighting with Snowsound sound-absorbing technology. The results of this combination are large architectural elements that incorporate LED lights in sound-absorbing panels. The ceiling suspension cables are adjustable.

**F**\_Oversize lux est un projet qui unit le concept d'éclairage technique avec la technologie phono-absorbante Snowsound. A partir de l'intégration de ces deux aspects sont nés de véritables éléments architecturaux de grandes dimensions, avec des lumières à LED encaissées dans les panneaux phono-absorbants. Les câbles de suspension au plafond sont réglables.

**D**\_Oversize lux ist ein Projekt, bei dem technische Beleuchtung und schallabsorbierende Snowsound-Technologie miteinander verschmelzen. Aus der Verbindung dieser Elemente sind echte Architekturobjekte von beachtlicher Größe entstanden, deren LED-Lichter in die schalldämpfenden Paneele integriert sind. Die Stahlseile zum Anbringen an die Decke sind verstellbar.

**E**\_Oversize lux es un proyecto que fusiona el concepto de iluminación técnica con la tecnología fonoabsorbente Snowsound. Integrando estos ámbitos se crearon verdaderos componentes arquitectónicos, de gran tamaño, con lámparas LED integradas en los paneles fonoabsorbentes. Los cables para colgarlos del techo son ajustables.



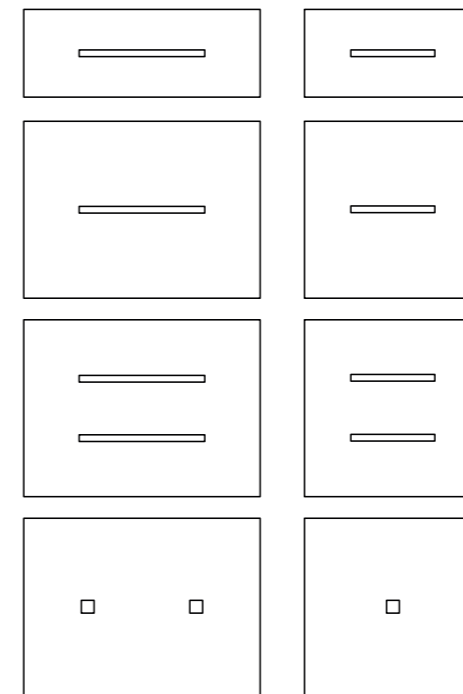

## Air purification

**I** Le lampade Oversize lux con led lineari possono essere equipaggiate con la tecnologia di purificazione dell'aria AIR PURIFICATION che consente inoltre di incrementare la sostenibilità energetica riutilizzando l'energia persa in calore dalle sorgenti LED. Il calore provocato dalle sorgenti luminose crea un flusso d'aria ascendente che viene convogliato attraverso un filtro anodizzato con ioni di argento in grado di abbattere la carica batterica in modo significativo. Le lampade sono state testate presso un laboratorio di analisi microbiologiche per verificarne la capacità di abbattimento della carica microbica presente nell'aria.

**EN** The Oversize lux lamps with linear LEDs can be equipped with the AIR PURIFICATION technology, which also grants increased energy sustainability by reusing the energy lost in heat from the LED sources. The heat caused by the light sources creates an ascending air flow which is conveyed through an anodized filter with silver ions, capable of significantly reducing the bacterial load. The lamps were tested in a microbiological analysis laboratory to verify their ability to reduce the microbial load in the air.

**F** Les lampes Oversize lux avec led linéaires peuvent être dotées de la technologie de purification de l'air AIR PURIFICATION, qui permet également d'augmenter la durabilité énergétique en réutilisant l'énergie perdue en chaleur par les sources LED. La chaleur provoquée par les sources de lumière crée un flux d'air ascendant qui est acheminé à travers un filtre anodisé aux ions d'argent capables de réduire considérablement la charge bactérienne. Les lampes ont été testées dans un laboratoire d'analyses microbiologiques pour en vérifier la capacité de réduction de la charge microbienne dans l'air.

**D** Die Leuchten Oversize Lux mit linearen LEDs können mit der Luftreinigungstechnologie AIR PURIFICATION ausgestattet werden, die einen nachhaltigeren Energieverbrauch ermöglicht, indem die in Form von Wärme verloren gegangene Energie der LED-Lichtquellen wiederverwendet wird. Die Wärme der Lichtquellen erzeugt einen nach oben gerichteten Luftstrom, der durch einen mit Silberionen anodisierten Filter geleitet wird, der die bakterielle Belastung deutlich reduziert. Die Lampen wurden in einem mikrobiologischen Prüflabor auf ihre Fähigkeit getestet, die mikrobielle Belastung der Luft zu reduzieren.

**E** Las lámparas Oversize lux con LED lineales pueden incorporar la tecnología de purificación del aire AIR PURIFICATION que permite incrementar la sostenibilidad energética al reutilizar la energía perdida en forma de calor que ofrecen las fuentes LED. El calor generado por la iluminación crea un flujo de aire ascendente que se canaliza a través de un filtro anodizado con iones de plata capaz de reducir significativamente la carga bacteriana. Las lámparas han sido testadas en un laboratorio de análisis microbiológicos para verificar su capacidad de reducir la carga microbiana presente en el aire.

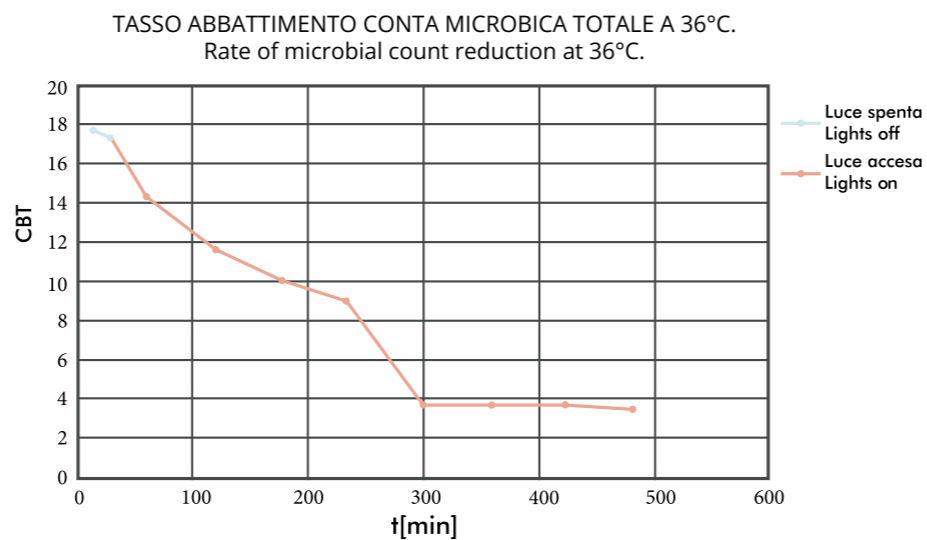
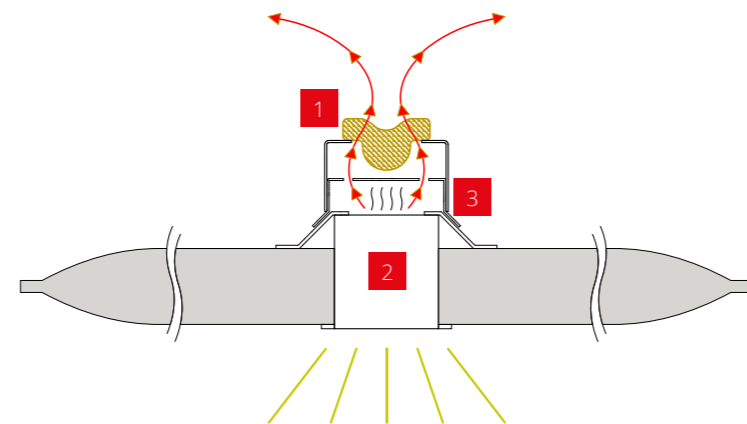

**I** Conta microbica totale a 36°C con lampada spenta e con lampada accesa.  
**EN** Total microbial count at 36°C with the lamp turned on and off.

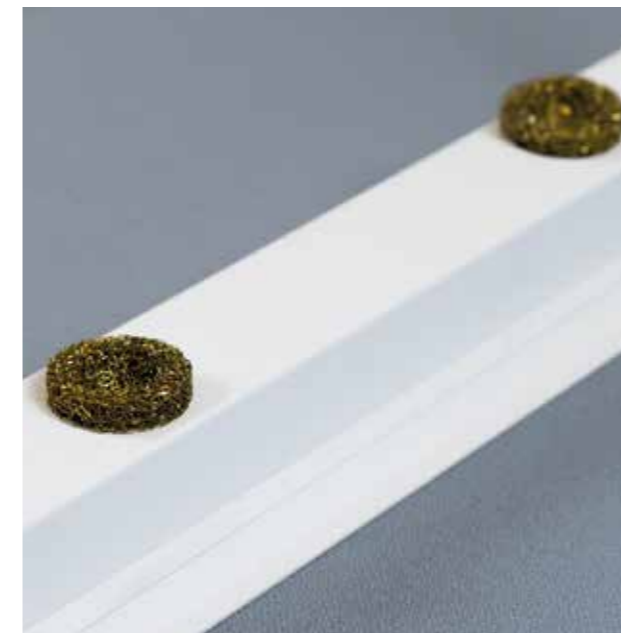

**1** **I** Filtro di purificazione dell'aria.  
**EN** Air purification filter.  
**F** Filtre de purification de l'air.  
**D** Luftreinigungsfilter.  
**E** Filtro de purificación del aire.

**2** **I** Corpo illuminante LED.  
**EN** LED element.  
**F** Corps d'éclairage à LED.  
**D** LED-Leuchtkörper.  
**E** Cuerpo de iluminación LED.

**3** **I** Flusso dell'aria.  
**EN** Air flow.  
**F** Flux d'air.  
**D** Luftstrom.  
**E** Flujo de aire



# TELETA

## Alessandro Zambelli



**I** Il progetto Teleta nasce con il preciso scopo di riutilizzare l'energia persa in calore delle sorgenti LED migliorandone la sostenibilità energetica, il calore provocato dalle lampadine crea un flusso d'aria ascendente che viene convogliato attraverso un filtro anodizzato con ioni di argento che abbattano la carica batterica in modo significativo. Le lampade sono state testate dal vero presso un laboratorio di analisi microbiologiche per attestare la capacità di abbattimento della carica microbica presente nell'aria.

**EN** The Teleta project was born with the precise purpose of reusing the energy lost as heat from LED sources, hence improving their energetic sustainability. The heat generated by the LED creates an ascending air flow that is conveyed through an anodized filter with silver ions that lowers the bacterial load significantly. The lamps have been tested in real life in a microbiological analysis laboratory to certify their ability to reduce the microbial load in the air.

**F** Le projet Teleta est né avec le but précis de réutiliser l'énergie perdue avec la chaleur des lampes LED en améliorant leur durabilité énergétique. La chaleur créée par les lampes donne lieu à un flux d'air ascendant qui est canalisé à travers un filtre anodisé avec des ions d'argent qui réduisent considérablement la charge bactérienne. Les lampes ont été testées en situation réelle dans un laboratoire de tests microbiologiques pour certifier leur capacité de réduction de la charge microbienne dans l'air.

**D** Das Teleta-Projekt wurde mit dem Ziel ins Leben gerufen, die in Form von Wärme verlorengangene Energie von LED-Quellen zurückzugewinnen und so die energetische Nachhaltigkeit zu verbessern. Die Wärme der Glühbirnen erzeugt einen nach oben gerichteten Luftstrom, der durch einen mit Silberionen anodisierten Filter geleitet wird, der die bakterielle Belastung deutlich reduziert. Die Lampen wurden in einem mikrobiologischen Prüflabor unter realen Bedingungen getestet, um ihre Fähigkeit zur Verringerung der mikrobiellen Belastung der Luft nachzuweisen.

**E** El proyecto Teleta nace con el objetivo de reutilizar la energía calorífica perdida que generan las fuentes LED, mejorando así su sostenibilidad energética. El calor generado por el LED crea un flujo de aire ascendente que se conduce hacia un filtro anodizado con iones de plata que reduce significativamente la carga bacteriana. Las lámparas han sido testadas en un laboratorio de análisis microbiológicos para certificar su capacidad de reducción de la carga microbiana presente en el aire.

**1** **I** Filtro di purificazione dell'aria.  
**EN** Air purification filter.  
**F** Filtre de purification de l'air.  
**D** Luftreinigungsfilter.  
**E** Filtro de purificación del aire.

**2** **I** Corpo illuminante LED.  
**EN** LED element.  
**F** Corps d'éclairage à LED.  
**D** LED-Leuchtkörper.  
**E** Cuerpo de iluminación LED.

**3** **I** Flusso dell'aria.  
**EN** Air flow.  
**F** Flux d'air.  
**D** Luftstrom.  
**E** Flujo de aire

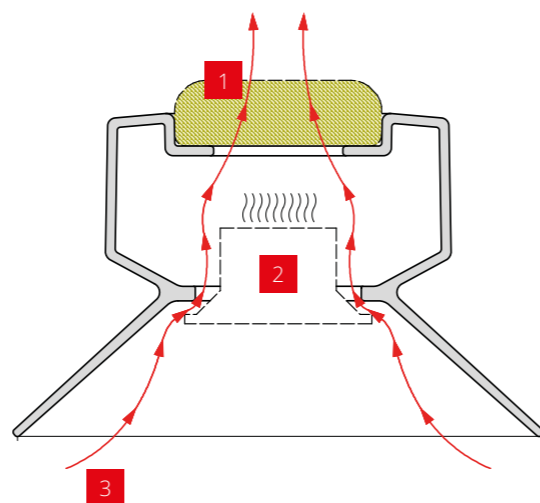



TASSO ABBATTIMENTO CONTA MICROBICA TOTALE A 36°C.  
Rate of microbial count reduction at 36°C.

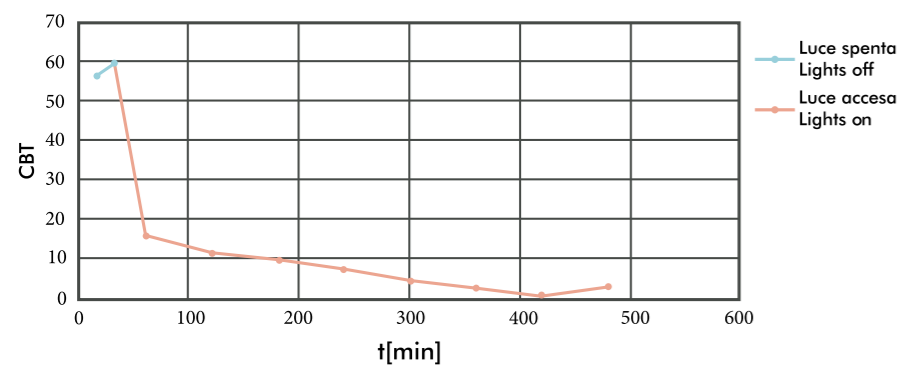

I\_Conta microbica totale a 36°C con lampada spenta e con lampada accesa.  
EN\_Total microbial count at 36°C with the lamp turned on and off.

TASSO ABBATTIMENTO CONTA MICROBICA TOTALE A 36°C.  
Rate of microbial count reduction at 36°C.

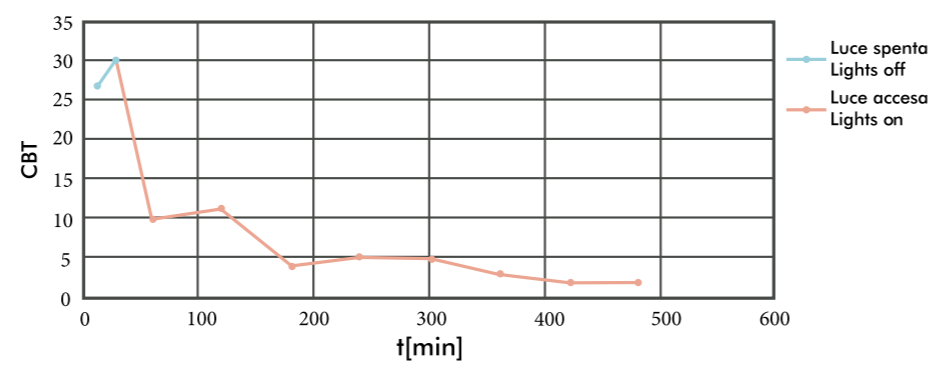

I\_Conta microbica totale a 36°C con lampada spenta e con lampada accesa.  
EN\_Total microbial count at 36°C with the lamp turned on and off.

## GIOTTO

### Sezgin Aksu



**I**\_Giotto è una linea di pannelli fonoassorbenti Snowsound di forma ovale o circolare, proposti in due versioni: Giotto ceiling, con sistema di appendimento a soffitto mediante cavi regolabili in altezza e Giotto wall, dotato di un particolare supporto a parete in acciaio che dal foro centrale sostiene il pannello inserito ad incastro.

**EN**\_Giotto is a line of Snowsound sound-absorbing panels in oval or circular shapes, available in two different versions: Giotto ceiling, the ceiling-mounted version with adjustable cables, and Giotto wall, which comes with a designated steel wall mount with a central hole to support the panel as it snaps in.

**F**\_Giotto est une ligne de panneaux phono-absorbants Snowsound de forme ovale ou circulaire, proposée en deux versions: Giotto ceiling avec suspension au plafond par des câbles réglables en hauteur et Giotto wall, muni d'un support particulier à paroi, en acier, qui soutient à partir d'une ouverture centrale le panneau fixé par emboîtement.

**D**\_Giotto ist eine Reihe von ovalen oder kreisförmigen Snowsound-Schalldämmpaneelen, die in zwei verschiedenen Versionen angeboten werden: Giotto ceiling, mit einem Deckenbefestigungssystem aus einem höhenverstellbaren Seilen, und Giotto wall wird mit einer speziellen Wandhalterung aus Stahl geliefert mit einer zentralen Öffnung, in dem die Paneele einrasten können.

**E**\_Giotto es una línea de paneles fonoabsorbentes Snowsound de forma ovalada o circular, que se propone en dos versiones: Giotto ceiling, con un sistema de suspensión fijado al techo mediante cables que permiten regular la altura, y Giotto wall, que presenta una peculiar sujeción a la pared elaborada en acero que sostiene el panel desde el orificio central mediante un sistema de encastre.





Alla Piazza Koya, Ravenna (Italy)

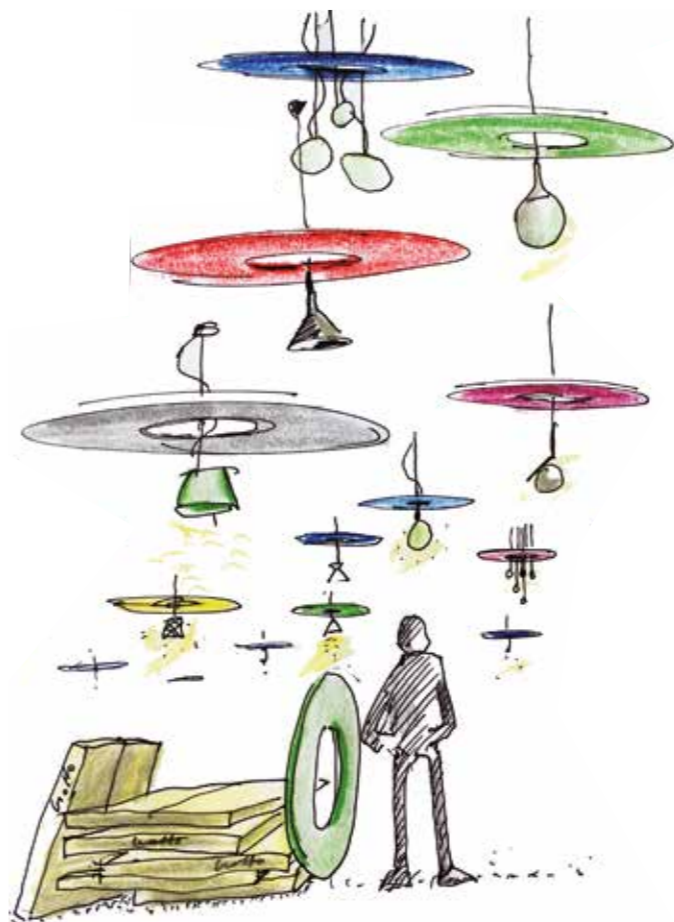



# GIOTTO LUX

## Sezgin Aksu



**I**\_Giotto lux è una linea di pannelli fonoassorbenti Snowsound di forma ovale o circolare al centro dei quali è alloggiato un corpo illuminante in metallo verniciato con sorgente luminosa a luce LED, protetta da un diffusore in polietilene satinato bianco opaco che consente di ottenere un'emissione omogenea della luce.

**EN**\_Giotto lux is a line of Snowsound sound-absorbing panels in oval or circular shapes, at the center of which is a light fixture in enamelled metal with a LED light source, protected by a shade in frosted white polyethylene that achieves uniform light distribution.

**F**\_Giotto lux est un panneau phono-absorbant Snowsound de forme ovale ou circulaire au centre duquel se trouve un élément d'éclairage en métal peint avec une source de lumière LED, protégée par un diffuseur en polyéthylène satiné blanc mat, qui permet d'obtenir une lumière homogène.

**D**\_Giotto Lux besteht aus einer Reihe von schallabsorbierenden Snowsound-Paneelen in ovaler oder kreisförmiger Form. In der Mitte befindet sich eine Leuchte aus emaillierten Metall mit einer LED-Lichtquelle, die durch einen Schirm aus matten weißen Polyethylen abgedeckt wird, der für eine gleichmäßige Lichtverteilung sorgt.

**E**\_Giotto lux es una línea de paneles fonoabsorbentes Snowsound de forma ovalada o circular en cuyo centro se ubica un cuerpo luminoso en metal barnizado con fuente de luz LED protegida por un difusor en polietileno satinado blanco opaco que permite conseguir una emisión homogénea de la luz.





ADI Design Museum, Milano (Italy)



Balsamiq, Bologna (Italy)

## SURF

### Caimi Lab



CE

**I**\_Pannelli fonoassorbenti con superficie frontale planare, realizzati con tecnologia Snowsound. I pannelli possono essere applicati direttamente a parete oppure a soffitto mediante 4 cavi regolabili in altezza.

**EN**\_Sound-absorbing panels with flat frontal surface, made with Snowsound technology. The panels can be applied directly to the wall or ceiling using 4 height-adjustable cables.

**F**\_Panneaux phono-absorbants avec surface frontale plane, fabriqué avec la technologie Snowsound. Les panneaux peuvent être appliqués directement au mur ou au plafond avec 4 câbles réglables en hauteur.

**D**\_Schallabsorbierende Paneele mit einer ebenen Vorderseite, hergestellt mit Snowsound-Technologie. Die Paneele können direkt an der Wand oder mithilfe von 4 höhenverstellbaren Seilen an der Decke befestigt werden.

**E**\_Paneles fonoabsorbentes con superficie frontal plana, realizados con tecnología Snowsound. Los paneles pueden colocarse directamente en la pared o bien suspenderse del techo utilizando 4 cables regulables en altura.





**I**\_Il pannello a soffitto è disponibile anche con foro centrale quadrato per ospitare corpi illuminanti o plafoniere facilmente reperibili in commercio.

**EN**\_The ceiling panel is also available with a square central hole that allows the application of lighting elements or ceiling lights easily found on the market.

**F**\_Les deux éléments qui composent les canapés Snowking peuvent être combinés entre eux pour créer les configurations voulues.

**D**\_Das Deckenpaneel ist auch mit einer quadratischen Öffnung in der Mitte erhältlich, um handelsübliche Beleuchtungskörper oder Deckenleuchten einzusetzen.

**E**\_El panel para techo también está disponible en su versión con abertura central cuadrada para la colocación de los diversos cuerpos luminosos o plafones disponibles en el mercado.



164 - Snowsound Technology

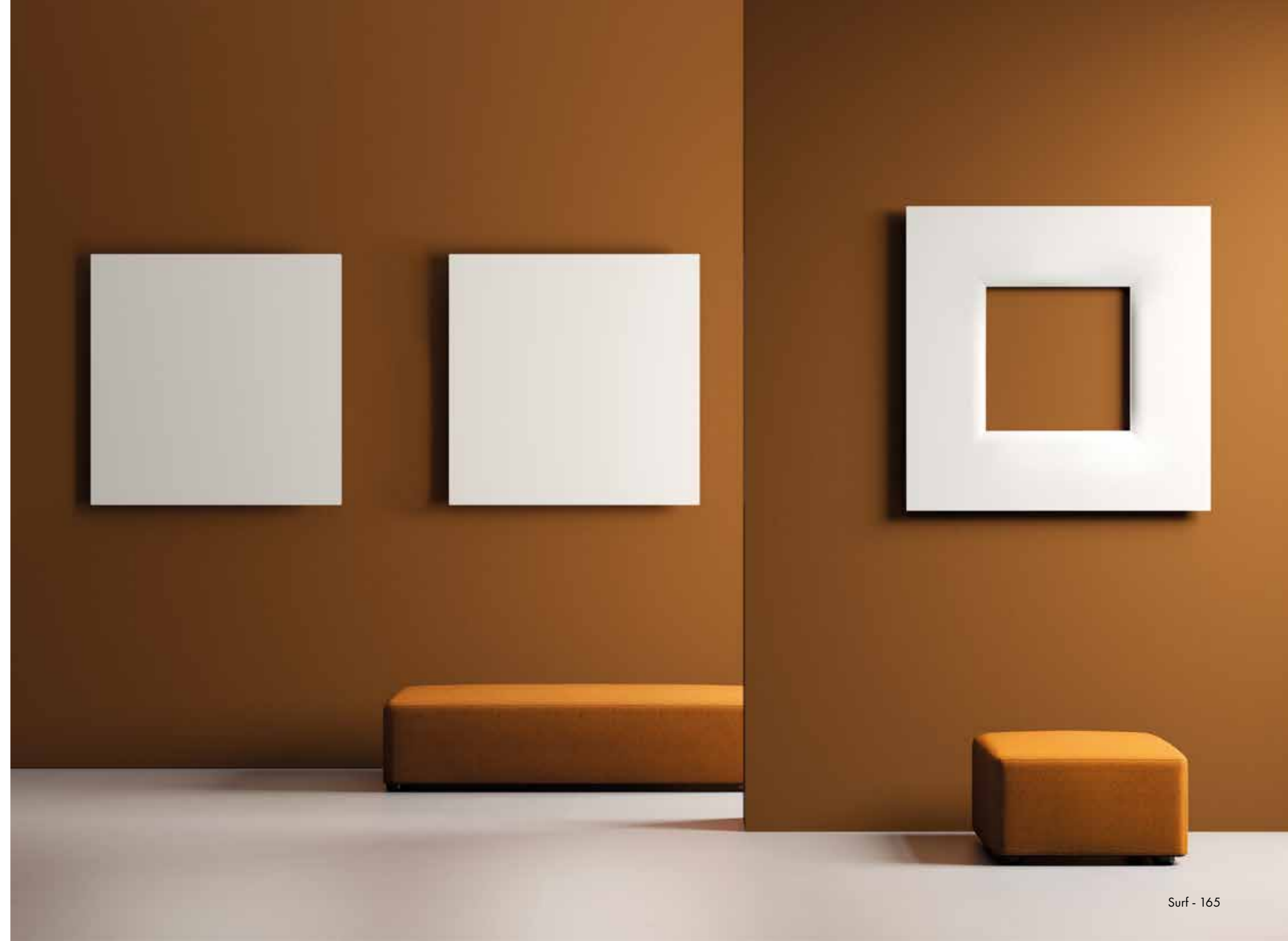

Surf - 165

# TL | TL LUX

## Design by Gio Ponti



**I**\_TL nasce da un progetto di Gio Ponti che nel '59 realizza l'auditorium del Time Life Building a New York e, per il soffitto, progetta degli elementi conici che oggi vengono proposti da Caimi anche come elementi fonoassorbenti singoli. La linea estremamente leggera di TL nasconde al suo interno la tecnologia Snowsound che consente di assorbire il rumore.

**EN**\_TL is the result of a project by Gio Ponti, who in 1959 built the auditorium of the Time Life Building in New York. For the ceiling, he designed conical elements that today are proposed by Caimi (also as single sound-absorbing elements).The extremely light line of TL conceals the Snowsound technology that allows you to absorb reverberation.

**F**\_TL est né d'un projet de Gio Ponti, qui avait réalisé en 1959 l'auditorium du Time Life Building à New York et avait projeté pour le plafond des éléments coniques qui sont aujourd'hui proposés par Caimi aussi comme éléments phono-absorbants individuels. La ligne extrêmement légère de TL cache à l'intérieur la technologie Snowsound qui permet d'absorber le bruit.

**D**\_TL entspringt einem Entwurf von Gio Ponti, der 1959 das Auditorium des Time Life Building in New York baute und für die Decke kegelförmige Elemente entwarf, die heute von Caimi wiederaufgenommen werden. Die extrem schlanke Linie von TL verbirgt in ihrem Inneren die Snowsound-Technologie zur Schalldämmung.

**E**\_TL surge de un proyecto de Gio Ponti que en 1959 proyecta el auditorio del Time Life Building en Nueva York, y diseña para el techo elementos cónicos que hoy propone Caimi también como elementos fonoabsorbentes individuales. La línea extremadamente liviana de TL esconde en su interior la tecnología Snowsound que hace posible la absorción del ruido.

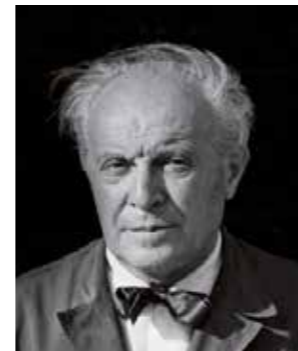

Time Life Building, New York





**I**\_Elementi fonoassorbenti tridimensionali a soffitto, realizzati con tecnologia Snowsound, proposti con o senza luce Led integrata. Ogni elemento è dotato di 3 cavi per sospensione a soffitto in acciaio cromato collegati ad un'unica piastra centrale.

**EN**\_Three-dimensional sound absorbing ceiling elements, made with Snowsound technology, with or without integrated Led light. Each element is equipped with 3 steel ceiling suspension cables connected to a single central plate. The extremely light line of TL conceals the Snowsound technology that allows you to absorb reverberation.

**F**\_Éléments phono-absorbants tridimensionnels fixés au plafond, réalisés avec la technologie Snowsound, proposés avec ou sans lumière Led intégrée. Chaque élément est muni de 3 câbles en acier chromé pour la suspension au plafond, reliés à une seule plaque centrale.

**D**\_Dreidimensionale Schalldämmelemente für die Deckenbefestigung mit Snowsound-Technologie, mit oder ohne eingebautes LED-Licht. Jedes Element ist mit drei an einer einzigen zentralen Platte festgemachten verchromten Stahlseilen für die Deckenbefestigung versehen.

**E**\_Elementos fonoabsorbentes tridimensionales fijados al techo, realizados con tecnología Snowsound, propuestos con o sin luz LED integrada. Cada elemento dispone de 3 cables de acero cromado para la suspensión del techo unidos a una única placa central.



## OBELISCO

Design by Gio Ponti



**I**\_Obelisco riprende un elemento progettato da Gio Ponti per un allestimento del 1965. Gio Ponti ha indagato molto il tema dell'obelisco utilizzandolo spesso nelle sue architetture e nei suoi allestimenti. Obelisco è un elemento fonoassorbente autoportante rivestito di tessuto Snowsound Fiber 1, completamente sfoderabile e lavabile, con struttura interna in poliestere e acciaio. Utilizzabile come bass trap.

**EN**\_Obelisco recovers an element designed by Gio Ponti for a 1965 installation. Gio Ponti has repeatedly investigated the theme of obelisks, often using them in his architecture and works. Obelisco is a freestanding sound-absorbing element covered in Snowsound Fiber 1 fabric, completely removable, washable, with an internal structure in polyester and steel. Usable as bass trap.

**F**\_Obelisco reprend un élément conçu par Gio Ponti pour une installation de 1965. Gio Ponti a examiné en profondeur le thème de l'obélisque qu'il a souvent utilisé dans ses architectures et installations. Obelisco est un élément phono-absorbant autoportant revêtu de tissu Snowsound Fiber 1, complètement amovible et lavable, avec une structure interne en polyester et acier. Utilisable comme bass trap.

**D**\_Obelisco ist einem von Gio Ponti für eine Raumeinrichtung von 1965 entworfenen Element nachempfunden. Gio Ponti hat das Thema des Obeliskens besonders vertieft und in seinen Architekturen und Einrichtungen oft benutzt. Obelisco ist ein selbsttragendes mit dem Stoff Snowsound Fiber 1 überzogenes Schalldämmelement, das vollständig abziehbar und waschbar ist. Die Innenstruktur ist aus Polyester und Stahl. Verwendbar als Bassfalle.

**E**\_Obelisco retoma un elemento proyectado por Gio Ponti para una instalación de 1965. Gio Ponti estudió exhaustivamente el tema del obelisco, utilizándolo con frecuencia en su arquitectura e instalaciones. Obelisco es un elemento fonoabsorbente con soporte autónomo revestido en tejido Snowsound Fiber 1, completamente desenfundable y lavable, con estructura interna en poliéster y acero. Se puede utilizar como trampa de graves.

“The obelisk teaches Architecture”

Gio Ponti





# KLIPPER

## Felcia Arvid



**I** Elementi fonoassorbenti a parete realizzati in poliestere rivestiti con tessuto Snowsound Fiber 8 Bouclé. Le forme ottenute tramite clips in acciaio inox evocano il movimento delle dune di sabbia, sinuose e ondegianti, dove anche la marcata matericità del tessuto di cui sono composti, rimanda alla miriade di granelli di sabbia che formano le dune. Il sistema fonoassorbente viene fissato a parete tramite una robusta staffa in acciaio verniciato. Nella parte superiore ed inferiore del pannello sono inseriti due tubi di irrigidimento in acciaio bloccati tramite particolari viti cromate.

**EN** A wall-mounted sound-absorbing features made of polyester with a Snowsound Fiber 8 Bouclé fabric covering. The shapes, which are underpinned by stainless steel clips, are reminiscent of undulating sand dunes and not only evoke a sense of sinuous movement but also, thanks to the distinctive materiality of the fabric, seem to allude to the myriad grains of sand. The sound-absorbing system is anchored to the wall by means of a sturdy bracket of epoxy-coated steel. Two steel stiffening tubes are inserted in the upper and lower part of the panel where they are held in place by special chromed screws.

**F** Éléments phono-absorbants à paroi en polyester revêtus avec le tissu Snowsound Fiber 8 Bouclé. Les formes obtenues au moyen de clips en acier inoxydable évoquent le mouvement des dunes de sable, sinueuses et ondulantes, et même la texture du tissu qui les compose évoque les myriades de grains de sable des dunes. Le système phono-absorbants est fixé à la paroi avec un support robuste en acier peint. Dans la partie supérieure et inférieure du panneau sont insérés deux tubes raidisseurs en acier fixés par des vis chromées spéciales.

**D** Schallabsorbierendes Wandelementen aus mit Snowsound Fiber 8 Bouclé-Gewebe bezogenem Polyester. Die mit Edelstahlclips erzeugten Formen erinnern an die geschwungenen und wellenartigen Bewegungen von Sanddünen, wobei auch die besondere Beschaffenheit des Gewebes, aus dem sie hergestellt sind, an die unzähligen Sandkörner einer Düne erinnert. Das schallabsorbierende System wird mit einer robusten Halterung aus lackiertem Stahl an der Wand befestigt. Zwei Versteifungsrohre aus Stahl sind im oberen und unteren Teil des Paneels eingesetzt und mit verchromten Spezialschrauben fixiert.

**E** Elementos fonoabsorbentes de pared en poliéster tapizados con tejido Snowsound Fiber 8 Bouclé. Las formas, que se obtienen mediante clips de acero inoxidable, evocan el movimiento de las dunas de arena, sinuosas y fluctuantes. Hasta la acentuada textura del tejido que lo compone evoca la infinidad de granos de arena de las dunas. Este sistema se fija a la pared mediante un sólido estribo de acero pintado. Para otorgarle rigidez, en la parte superior e inferior del panel se introducen dos tubos de acero que se bloquean por medio de unos tornillos cromados especiales.





## FLAT

Alberto Meda, Francesco Meda



CE

CE

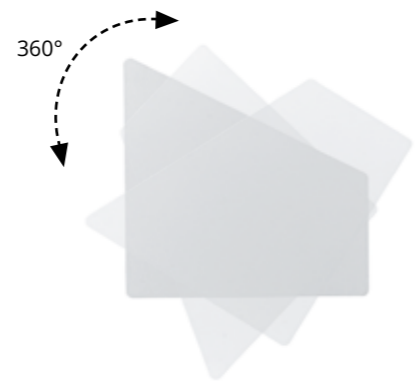
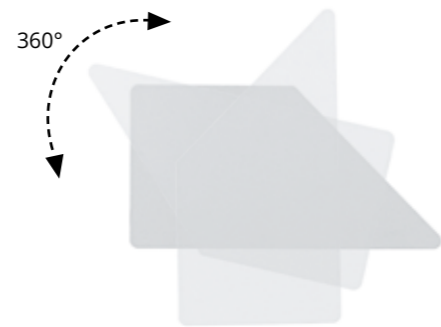

**I** Pannelli fonoassorbenti caratterizzati dalla superficie frontale perfettamente planare. I supporti a parete/soffitto sono dotati di uno snodo metallico posteriore che ne consente la rotazione e l'inclinazione.

**EN** Sound-absorbing panels characterized by the perfectly planar front surface. The wall/ceiling brackets are fitted with a rear metal hinge that can rotate and tilt the element.

**F** Panneaux phono-absorbants caractérisés par une surface frontale parfaitement plane. Les supports à paroi/plafond sont munis d'un dispositif métallique postérieur qui permet leur rotation et inclinaison.

**D** Schalldämmplatten mit perfekt ebener Frontfläche. Die Wand/Deckenbefestigungen sind mit einem hinteren Kupplungselement versehen, durch das das Element gedreht und geneigt werden kann.

**E** Se trata de paneles fonoabsorbentes caracterizados por una superficie frontal completamente plana. Los soportes fijados a la pared/techo disponen de una articulación metálica posterior que hace posible la rotación e inclinación.





## Flat lux

**I** I pannelli fonoassorbenti Flat montati a parete possono essere accessoriati con un sistema di retroilluminazione a LED.

**EN** The wall-mounted Flat sound-absorbing panels can be decorated with a backlit LED system.

**F** Les panneaux phono-absorbants Flat fixés aux parois peuvent être munis d'un système de rétroéclairage par lampes LED.

**D** Die an der Wand angebrachten schallabsorbierende Flat-Paneele können mit LED-Hintergrundbeleuchtung ausgestattet werden.

**E** Los paneles fonoabsorbentes Flat montados en las paredes pueden estar equipados con un sistema de retroiluminación LED.



## Flat totem

**I** Divisorio composto da 12 pannelli Flat contrapposti e supportati da una struttura in tubolare di acciaio cromato montata su una base in metallo verniciato. I pannelli, caratterizzati dalla superficie frontale planare, possono essere inclinati e ruotati.

**EN** Divider made up of 12 Flat panels set against each other and supported by a chromed tubular steel structure mounted on a painted metal base. The panels, characterized by the plane front surface, can be tilted and rotated.

**F** Cloison composée de 12 panneaux Flat opposés et soutenus par une structure en tube d'acier chromé montée sur une base en métal verni. Les panneaux caractérisés par une surface frontale parfaitement plane peuvent être inclinés ou tournés.

**D** Besteht aus 12 sich gegenüberstehenden Flat-Paneelen, die an einem Ständer aus verchromtem Stahlrohr mit einem Sockel aus lackierten Metall befestigt werden. Die Paneele, gekennzeichnet durch eine ebene Frontfläche, können gedreht und geneigt werden.

**E** Mampara divisoria compuesta de 12 paneles Flat contrapuestos y sujetos a una estructura en tubular de acero cromado montada sobre una base de metal barnizado. Los paneles, caracterizados por una superficie frontal plana, pueden rotar e inclinarse.



## FLOAT

Alberto Meda, Francesco Meda



**I** Sistema fonoassorbente modulare dotato di pannelli realizzati con tecnologia Snowsound, le linee essenziali e le molteplici possibilità di configurazione consentono di creare eleganti e funzionali soluzioni per piccoli e grandi ambienti.

**EN** A modular sound-absorbing system made up of panels made with Snowsound technology. Thanks to their minimalist styling and multiple compositional possibilities, Float panels offer elegant and functional solutions for small and large spaces alike.

**F** Système phono-absorbants modulaire muni de panneaux réalisés avec la technologie Snowsound, aux lignes épurées et offrant de nombreuses possibilités de configuration qui permettent de créer des solutions élégantes et fonctionnelles pour des espaces petits ou grands.

**D** Modulares Schallabsorptionssystem aus mit Snowsound-Technologie hergestellten Paneelen. Die essentiellen Linien und die vielen Konfigurationsvarianten ermöglichen die Schaffung von eleganten und funktionellen Lösungen für kleine und große Räume.

**E** Sistema fonoassorbente modular, con paneles que incorporan la tecnología Snowsound. Con sus líneas limpias y sus múltiples posibilidades de configuración, permite crear soluciones elegantes y funcionales, tanto para espacios grandes como pequeños.





**I**\_Il telaio modulare è realizzato in acciaio cromato e consente di ospitare pannelli fissati alla struttura mediante giunti articolati. I pannelli possono essere posizionati planari oppure inclinati sul loro asse maggiore consentendo di creare interessanti configurazioni tridimensionali. Il sistema è dotato di cavi di regolazione in altezza. L'inclinazione dei pannelli, oltre a consentire diverse configurazioni estetiche, consente, dove necessario, di migliorare l'aerazione e il passaggio della luce.

**EN** \_Pivot joints on the modular chromed steel frame fix the panels to the structure. The panels can be hung along a flat plane or else tilted on their major axis to create interesting three-dimensional compositions. The system is equipped with height-adjustable cables. The panels can be tilted not just to create desired patterns and aesthetic compositions but also to improve ventilation and the passage of light.

**F**\_Le cadre modulaire est en acier chromé et peut recevoir des panneaux fixés à la structure au moyen de joints articulés. Les panneaux peuvent être positionnés à plat ou inclinés sur leur axe principal, ce qui permet de créer d'intéressantes configurations tridimensionnelles. Le système est muni de câbles pour régler la hauteur. L'inclinaison des panneaux permet non seulement de réaliser différentes configurations esthétiques, mais aussi d'améliorer la ventilation et le passage de la lumière le cas échéant.

**D**\_Am aus verchromtem Stahl bestehenden modularen Rahmen werden Paneele befestigt, die mit Hilfe von Gelenkverbindungen an der Struktur fixiert werden. Die Paneele können flach oder um ihre Hauptachse gekippt positioniert werden, wodurch interessante dreidimensionale Konfigurationen entstehen. Das System ist mit höhenverstellbaren Seilen ausgestattet. Die Neigung der Paneele ermöglicht nicht nur verschiedene gestalterische Konfigurationen, sondern bei Bedarf auch eine Verbesserung der Belüftung und des Lichteinfalls.

**E**\_El bastidor modular es de acero cromado y permite albergar paneles que se fijan a la estructura mediante empalmes articulados. Los paneles se pueden colocar en sentido horizontal o inclinados sobre su eje mayor. De esta forma es posible crear interesantes configuraciones tridimensionales. El sistema consta de cables de regulación en altura. La inclinación de los paneles no solo da lugar a variadas configuraciones estéticas sino que, cuando es necesario, permite mejorar la ventilación y el paso de la luz.



## FLAP

Alberto Meda, Francesco Meda



CE

CE

**I** Molto più che un pannello fonoassorbente, Flap è un oggetto di design con grande forza estetica e formale che può dar vita ad infinite composizioni con disegni sempre differenti. Un sistema modulare brevettato, innovativo sia per la tecnologia Snowsound applicata, sia per l'idea del pannello inteso come complemento d'arredo che si inserisce con trasversalità in ogni ambiente che necessiti di una correzione acustica.

**EN** More than just a sound-absorbing panel, Flap is a design piece with considerable aesthetic and formal impact which can create a wide array of compositions with designs that are always new. This patented modular system is completely innovative in the applied Snowsound technology and in the notion of the panel as a furnishing accessory that fits perfectly in any room that requires an acoustic adjustment.

**F** Flap ne se contente pas d'être un panneau phono-absorbant. Véritable objet design, sa force esthétique et formelle permet une infinité de compositions aux expressions toujours différentes. Le système modulable breveté est innovant sur deux fronts: la technologie Snowsound d'une part, d'autre part la manière dont le panneau s'inscrit parfaitement dans l'ameublement de tout espace exigeant une correction acoustique.

**D** Mehr noch als ein schalldämpfendes Paneel ist Flap ein Designgegenstand mit einer unglaublichen formalen Ästhetik, der unendlich viele unterschiedliche Formen annehmen kann. Ein patentiertes modulares System, das dank der zum Einsatz kommenden Snowsound- Technologie und dank der Idee des Paneels, das als Einrichtungsgegenstand dient, innovativ an jedem Ort zum Einsatz kommen kann, an dem die Akustik verbessert werden soll.

**E** Flap no es tan sólo un panel acústico absorbente, Flap es un objeto de diseño con un notable impacto estético y formal para crear composiciones infinitas con formas cada vez diferentes. Un sistema modular patentado, innovador tanto por la tecnología Snowsound empleada, como por concebir el panel como complemento de decoración que se inserta perfectamente en todas las salas que necesitan una corrección acústica.

Flap



Maxi Flap







Edison, Milano (Italy)

**I**\_I pannelli Flap sono dotati nella parte posteriore di una piastra in acciaio cromato collegata mediante uno snodo sferico articolato ad un braccio in acciaio cromato che può essere fissato direttamente a parete o a soffitto. Lo snodo permette di ruotare il pannello di 360° e di inclinarlo in tutte le direzioni per personalizzare sia gli aspetti estetici del prodotto che quelli di resa acustica.

**EN**\_Flap panels feature a rear chrome-plated steel plate connected by an articulated spherical hinge to a chrome-plated steel arm that can be mounted directly to the wall or to a ceiling. The hinge allows the panel to rotate 360° and incline in any direction, in order to personalise the aesthetic aspects and the acoustic performance of the product.

**F**\_La partie postérieure des panneaux Flap est dotée d'une plaque en acier chromé reliée, au moyen d'une liaison rotule, à un bras en acier chromé qui peut être fixé directement au mur ou au plafond. La liaison rotule permet de pivoter le panneau sur 360° et de l'incliner dans toutes les directions afin d'en personnaliser tant les aspects esthétiques que le rendement acoustique.

**D**\_Die Flap Paneele bestehen aus einer verchromten Stahlplatte auf der Rückseite, die mit einem Arm aus verchromtem Stahl mit Kugelgelenk direkt an der Wand oder der Decke angebracht werden kann. Durch das Gelenk kann das Paneel um 360° gedreht werden und so in alle Richtungen geneigt werden, wodurch das Produkt hinsichtlich der Ästhetik und der Akustikleistung an individuelle Bedürfnisse angepasst werden kann.

**E**\_Los paneles Flap llevan en la parte posterior un placa de acero cromado conectada trámite una articulación esférica a un brazo de acero cromado que se puede instalar directamente en la pared o en el techo. Gracias a la articulación esférica el panel puede girar 360° y inclinarse en todas las direcciones para personalizar tanto los aspectos estéticos del producto como también la calibración acústica.



Identità Golose, Milano (Italy)



Tentazioni ristorante, Bergamo (Italy)

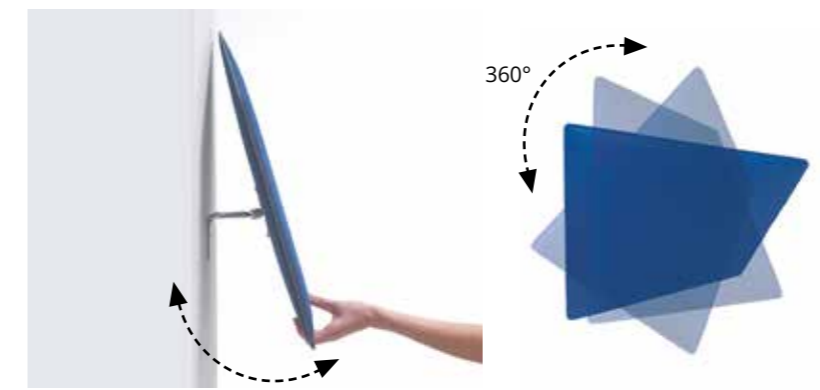

## Flap ceiling

**I** I telai a soffitto realizzati in acciaio cromato sono dotati di bracci mobili, ai quali vengono applicati i pannelli Flap mediante giunti articolati. I telai sono modulari e possono essere collegati in linea fra di loro. I pannelli possono essere ruotati e inclinati per generare configurazioni planari, concave o convesse in base alle esigenze estetiche ed acustiche. Le configurazioni possono essere facilmente modificate in qualsiasi momento.

**EN** The ceiling-mounted frames are in chrome-plated steel, fitted with mobile arms, to which Flap panels are anchored with articulated hinges. The frames are modular and can be connected together in a parallel line. The panels can be rotated and inclined to make planar, concave or convex configurations, depending on aesthetic and acoustic needs. The configurations can be easily adjusted at any time.

**F** Les châssis de montage plafond en acier chromé sont dotés de bras mobiles auxquels les panneaux Flap sont fixés au moyen de liaisons rotule. Les châssis sont modulables et peuvent être reliés entre eux de manière linéaire. Les panneaux pivotants et inclinables permettent de former des agencements planes, concaves ou convexes selon les exigences esthétiques et acoustiques. Les agencements sont aisément modifiables à tout moment.

**D** Die Rahmen aus verchromtem Stahl an der Decke verfügen über bewegliche Arme, an denen die Flap Paneele über die Drehgelenke angebracht werden. Die Rahmen bestehen aus Modulen, die in einer Reihe miteinander verbunden werden können. Die Paneele können gedreht und geneigt werden, um je nach gewünschter Ästhetik und Akustik eben, konkav oder konvex ausgerichtet zu werden. Die Einstellungen können einfach und jederzeit verändert werden.

**E** El bastidor de acero cromado del techo está equipado con brazos móviles, a los que se aplican los paneles Flap mediante articulaciones esféricas. Los bastidores son modulares y se pueden colocar conectándolos en batería. Los paneles se pueden girar e inclinar para crear configuraciones planas, cóncavas o convexas conforme a las necesidades estéticas y acústicas. Las configuraciones se pueden modificar fácilmente en cualquier momento.



## Flap lux

**I** I pannelli fonoassorbenti Flap montati a parete possono essere accessoriati con un sistema di retroilluminazione a LED. Anche il sistema a telaio sospeso Flap Ceiling è accessoriabile con lampade a LED orientabili di 180° per ottenere l'illuminazione desiderata.

**EN** The wall-mounted Flap sound-absorbing panels can be decorated with a backlit LED system. The suspended Flap Ceiling frame system can be accessorized with 180° directional LED lighting to achieve the desired illumination.

**F** Les panneaux phono-absorbants Flap fixés aux parois peuvent être munis d'un système de rétroéclairage par lampes LED. Le système à châssis suspendu Flap Ceiling peut également être muni de lampes LED orientables à 180° pour obtenir l'éclairage souhaité.

**D** Die an der Wand angebrachten schallabsorbierende Flap-Paneele können mit LED-Hintergrundbeleuchtung ausgestattet werden. Auch das von der Decke abgehängte Flap Ceiling-System kann mit bis zu 180° schwenkbaren LED-Leuchten ausgerüstet werden, um die gewünschten Beleuchtungseffekte zu erzielen.

**E** Los paneles fonoabsorbentes Flap montados en las paredes pueden estar equipados con un sistema de retroiluminación LED. También el sistema con bastidor suspendido Flap Ceiling se puede equipar con focos LED orientables hasta 180° para conseguir la iluminación que se desea.

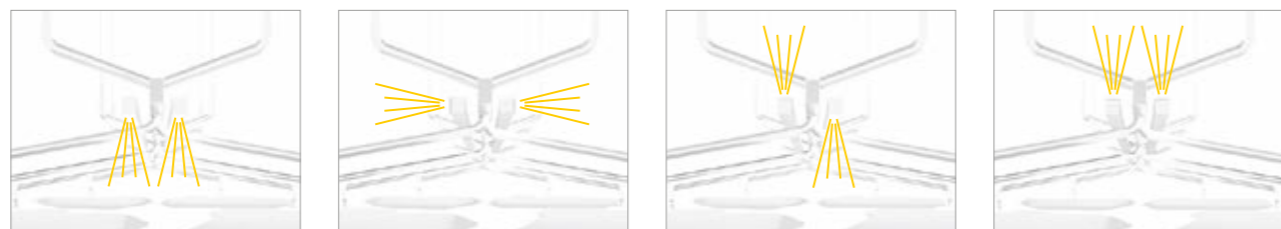
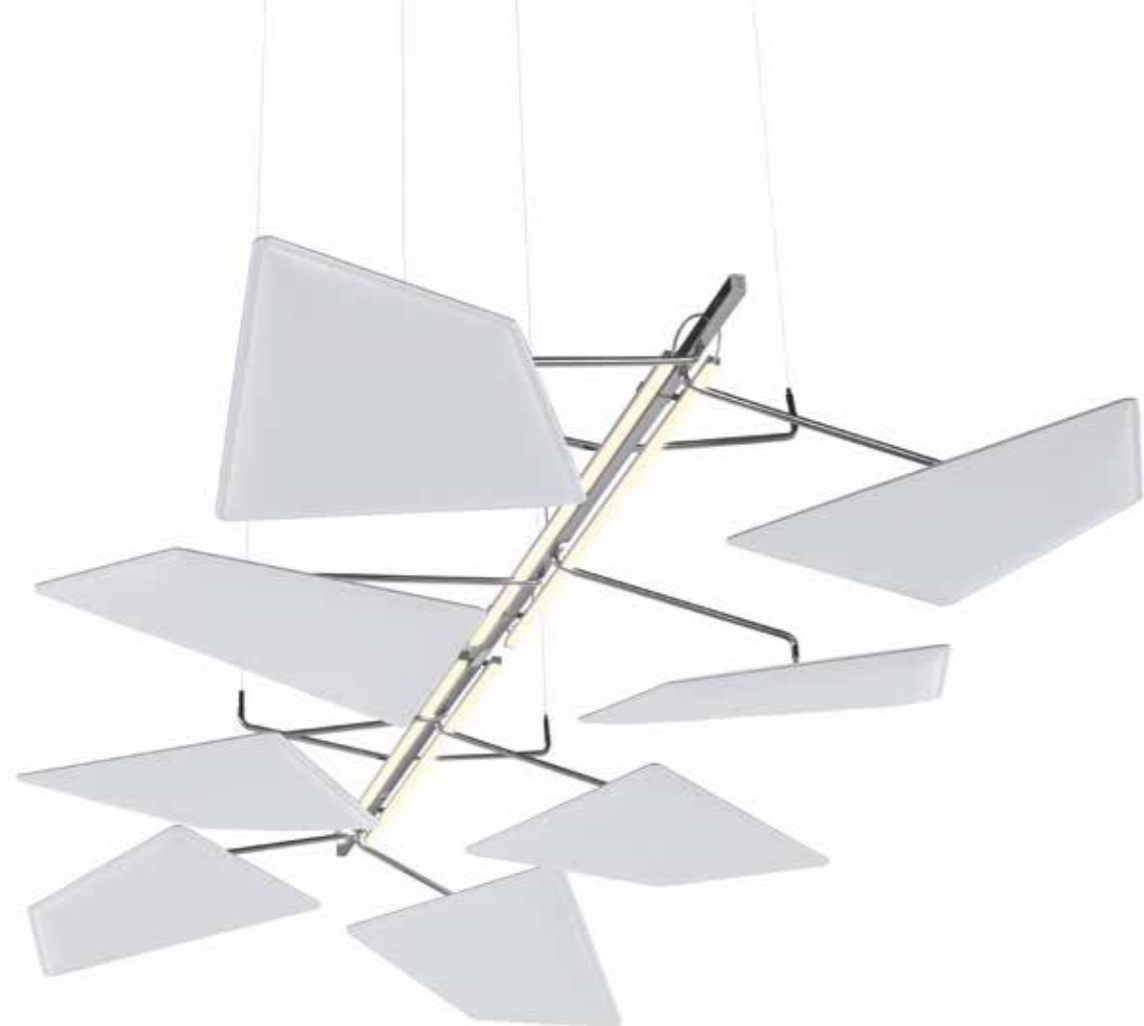

Snowsound showroom, Los Angeles (U.S.A.)



## Flap totem

**I**\_Flap Totem è composto da una struttura in acciaio cromato alla quale sono fissati 6 pannelli Flap orientabili. La base della struttura è in acciaio verniciato. Elegante e pratico, unisce la funzione di correzione acustica alla caratteristica di poter essere facilmente spostato e riposizionato.

**EN**\_Flap Totem is a chrome-plated steel structure onto which are anchored six adjustable Flap panels. The base is in epoxy powder-coated steel. It is elegant yet practical and combines the feature of acoustic correction with the distinction of being easy to move and repositioned as required.

**F**\_Flap Totem se compose d'une structure en acier chromé à laquelle sont fixés 6 panneaux Flap orientables. La base de la structure est en acier peint. Élégant et pratique, il combine la fonction de correction acoustique à sa capacité d'être facilement déplacé et repositionné.

**D**\_Flap Totem besteht aus einer verchromten Stahlstruktur, an welcher 6 schwenkbare Flap-Paneele befestigt sind. Der Unterbau der Struktur ist aus lackiertem Stahl. Elegant und praktisch in der Form, vereint das gleich zwei Funktionen: es sorgt für die Schallregulation in Räumen und lässt sich problemlos von einem Ort zum anderen transportieren.

**E**\_Flap Totem consta de una estructura de acero cromado a la que se anclaron 6 paneles Flap orientables. La base de la estructura es de acero barnizado. Elegante y práctico, compagina la función de corrección acústica con la característica que se puede trasladar fácilmente y colocar en otra parte.



Officescapes, Denver (U.S.A.)



## V-Flap

**I** Con V-Flap si possono realizzare soluzioni fonoassorbenti di grande impatto visivo. Il telaio in acciaio cromato, tenuto in sospensione da sottili cavi metallici, ed i due pannelli fonoassorbenti in posizione inclinata generano l'immagine di due ali che volano nello spazio.

**EN** V-Flap makes it possible to achieve sound-absorbing solutions with enormous visual impact. The chrome-plated steel frame, held in suspension by metal cables, and the two leaning sound-absorbing panels create the image of two wings that fly through space.

**F** V-Flap permet de réaliser des solutions de phono-absorbance d'un grand impact visuel. Le chassis en acier chromé, suspendu par de minces câbles en métal, et les deux panneaux phono-absorbants placés en position inclinée créent l'image de deux ailes qui volent dans l'espace.

**D** Mit V-Flap kann man schalldämmende Lösungen mit einer großen optischen Wirkung realisieren. Der Rahmen aus verchromtem Stahl, der durch dünne Metallkabel aufgehängt wird, sowie die beiden schräg angebrachten schalldämmenden Paneele wirken wie zwei Flügel, die sich im Raum bewegen.

**E** V-Flap se pueden realizar soluciones fonoabsorbentes de notable impacto visual. El bastidor de acero cromado, que cuelga de delgados cables metálicos y los dos paneles fonoabsorbentes colocados inclinados se perciben como dos alas volando en el espacio.

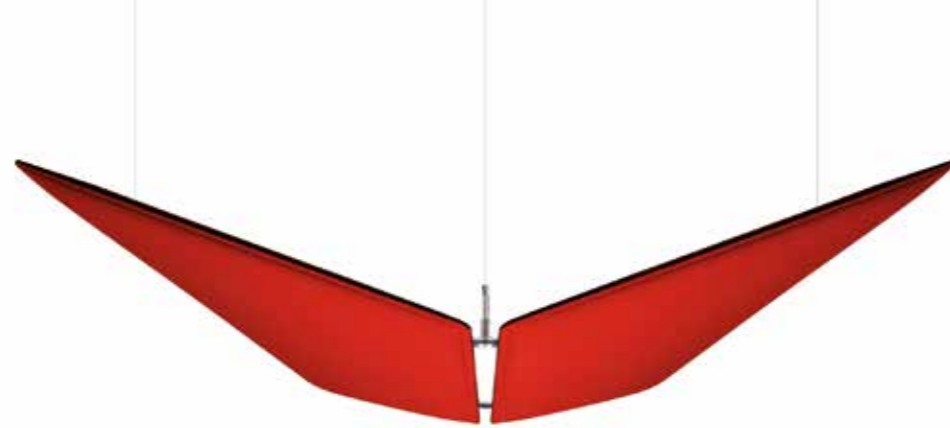

Gruppo Generali Spa, Mogliano Veneto TV (Italy)



# BAFFLE

Marc Sadler



**I**\_Baffle è un sistema brevettato che permette di sospendere a soffitto i pannelli fonoassorbenti Snowsound, esaltandone le caratteristiche di leggerezza ed eleganza. La possibilità di regolazione in altezza dei cavi e la varietà di misure e colori disponibili, permettono di ottenere composizioni sia esteticamente che acusticamente personalizzate. Il sistema brevettato di unione del pannello ai cavi è totalmente a scomparsa: un piccolo giunto cilindrico nasconde al suo interno il sistema di fissaggio.

**EN**\_Baffle is a patented system designed to hang Snowsound sound-absorbing panels from the ceiling, showcasing its lightness and elegance. The adjustable height of the cables and the array of sizes and colours available make it possible to achieve compositions that can be personalized for aesthetics and sound. The patented joining system of the panel to the cables is completely invisible: a small cylindrical joint hides the anchoring system inside.

**F**\_Baffle est un système breveté qui permet de suspendre au plafond les panneaux phono-absorbants Snowsound, en exaltant leurs caractéristiques de légèreté et d'élégance. La possibilité de régler les câbles en hauteur et la variété de dimensions et de coloris disponibles, permettent d'obtenir des compositions personnalisées aussi bien esthétiquement qu'acoustiquement. Le système breveté d'accrochage des panneaux aux câbles est totalement escamotable: un petit joint cylindrique cache en son intérieur le système de fixation.

**D**\_Baffle ist ein patentiertes System für die Deckenmontage der schallabsorbierenden Snowsound-Paneele. Auf diese Weise werden die Eigenschaften der Leichtigkeit und der Eleganz in den Vordergrund gestellt. Durch die Möglichkeit die Länge der Stahlseile zu variieren und die Auswahl an zur Verfügung stehenden Maßen und Farben erhält man ästhetisch und akustisch gesehen personalisierte Lösungen. Die patentierte Halterung der Paneele an den Stahlseilen ist völlig unsichtbar: eine kleine zylinderförmige Verbindung verbirgt in ihrem Inneren das Befestigungssystem.

**E**\_Baffle es un sistema patentado para colgar del techo los paneles fonoabsorbentes Snowsound, acentuando su elegancia y ligereza características. Gracias a la posibilidad de ajustar la longitud de los cables y el surtido de colores y medidas disponibles, se pueden personalizar estéticamente y acústicamente las configuraciones. El sistema patentado de unión del panel con los cables es totalmente oculto: el sistema de fijación queda escondido dentro de un pequeño empalme cilíndrico.

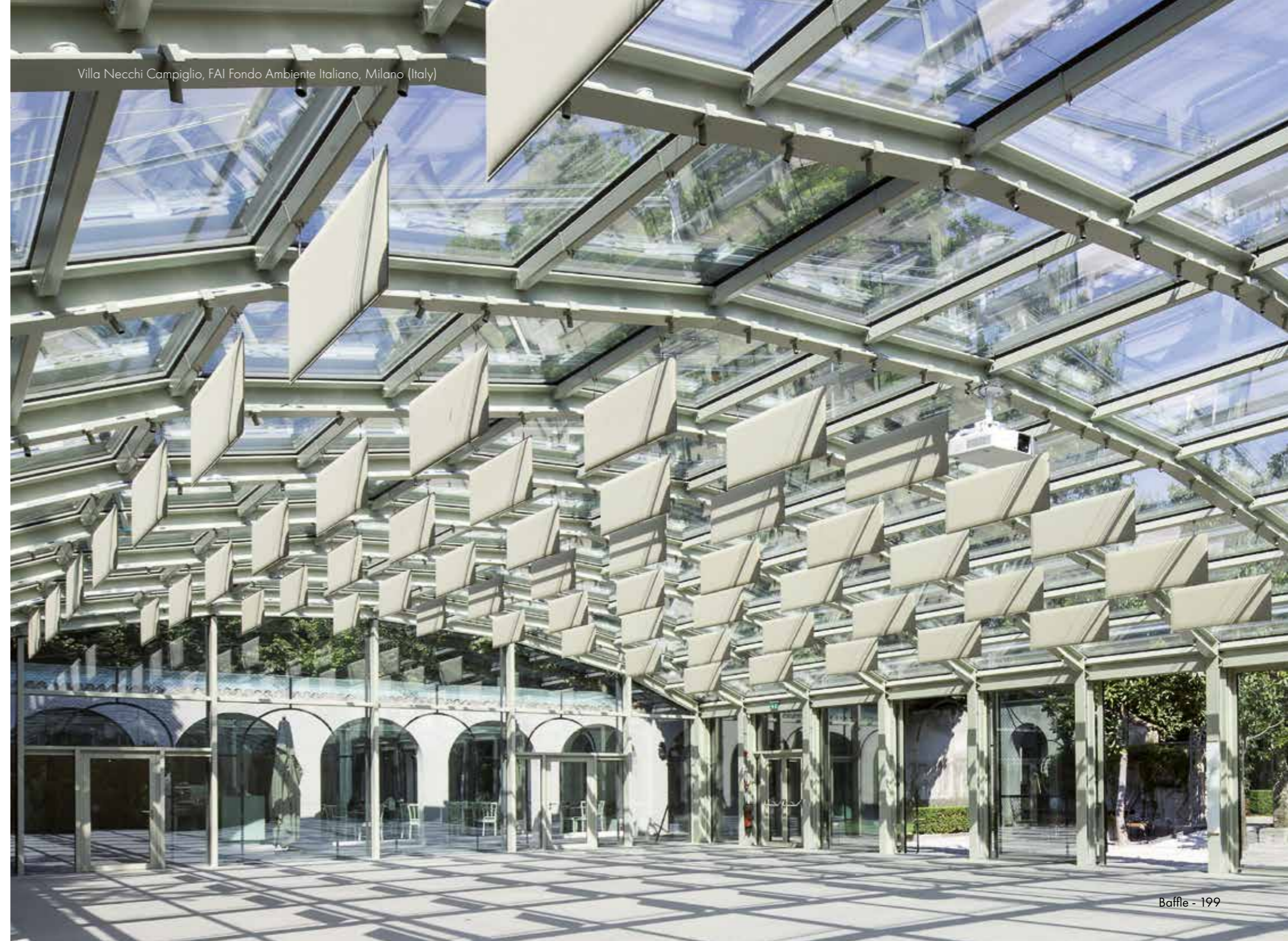

Alla Piazza Koya, Ravenna (Italy)



200 - Snowsound Technology



Civic Center, Miami (U.S.A.)

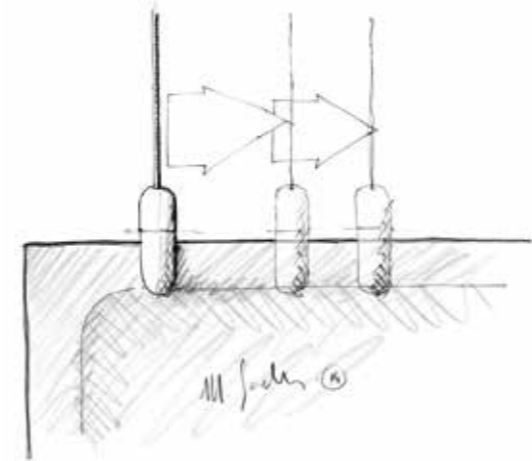

# BAFFLE OVERSIZE

Marc Sadler



**I**\_Baffle Oversize è un sistema brevettato che permette di sospendere a soffitto i pannelli fonoassorbenti Snowsound di grandi dimensioni. Il sistema di unione del pannello ai cavi, nasconde al suo interno il meccanismo di fissaggio al pannello e il sistema di regolazione in altezza dei cavi. Gli agganci sono in metallo pressofuso cromato e sono posizionabili lungo il bordo superiore del pannello in modo da semplificare l'installazione a soffitto.

**EN**\_Baffle Oversize is a patented system meant for hanging large Snowsound sound-absorbing panels from the ceiling. The connecting system that joins panel and cables hides inside both the panel fixing mechanism and the regulation system for cables' height. The anchors are in die-cast, chrome-plated metal and can be freely positioned along the whole upper edge of the panel in order to simplify ceiling installation.

**F**\_Baffle Oversize est un système breveté qui permet de suspendre au plafond les panneaux phono-absorbants Snowsound de grandes dimensions. Le système de fixation des panneaux aux câbles cache à l'intérieur le mécanisme de fixation au panneau et le système de réglage en hauteur des câbles. Les crochets sont en métal coulé sous pression chromé et peuvent être placés le long du bord supérieur du panneau de manière à simplifier l'installation au plafond.

**D**\_Baffle Oversize ist ein patentiertes System, mit dem große schallabsorbierende Snowsound-Paneele an die Decke gehängt werden können. Das System für die Verbindung des Paneels mit den Stahlseilen ist nicht sichtbar, indem sowohl die Befestigung am Paneel als auch die Verstelleinrichtung für die Seillänge versteckt werden. Die Verankerungen bestehen aus verchromtem Metallguss und können am oberen Rand des Paneels befestigt werden, um das Anbringen an der Decke zu erleichtern.

**E**\_Baffle Oversize es un sistema patentado para colgar del techo los paneles fonoabsorbentes Snowsound de gran tamaño. En el interior del sistema de unión del panel a los cables, se esconde el mecanismo de fijación al panel y el sistema de ajuste de la altura de los cables. Las sujeciones son de metal fundido cromado y se pueden colocar a lo largo del borde superior del panel para que resulte más sencilla la instalación en el techo.





## BAFFLE DIRECT 22|44

Marc Sadler



**I**\_Sistema brevettato di attacco diretto a soffitto, disponibile per i pannelli fonoassorbenti Snowsound Baffle Direct con altezza 22/44 cm. Il particolare design degli attacchi è stato studiato per garantire una facile e rapida installazione dei pannelli.

**EN**\_Patented direct attachment system for ceiling mounting, available for the 22/44 cm-high Snowsound Baffle Direct sound absorbing panel. The fixing points have been carefully designed for quick and easy panel installation.

**F**\_Système breveté d'attache directe pour plafond, disponible pour les panneaux phono-absorbants Snowsound Baffle Direct d'une hauteur de 22/44 cm. Le design particulier des attaches a été pensé pour assurer une installation facile et rapide des panneaux.

**D**\_Patentiertes System zur Direktanbringung an Decke, erhältlich für die Schallabsorptionspaneele Snowsound Baffle Direct mit einer Höhe von 22/44 cm. Das spezielle Design der Halterungen gewährleistet eine einfache und schnelle Montage der Paneele.

**E**\_Sistema patentado de anclaje directo al techo, que está disponible para los paneles fonoabsorbentes Snowsound Baffle Direct de 22/44 cm de altura. El particular diseño de los anclajes se estudió a efectos de garantizar que los paneles se puedan instalar fácil y rápidamente.





## TRA LIGHT Marc Sadler



**I** Il sistema Tra light consente di sospendere i pannelli realizzati con tecnologia Snowsound ad una coppia di cavi in acciaio mediante giunti metallici oscillanti posti in corrispondenza degli angoli superiori. I pannelli possono essere fissati liberamente lungo i cavi, mentre i giunti oscillanti mantengono sempre la perfetta verticalità del pannello.

**EN** The Tra light system allows the panels made with Snowsound technology to be suspended from a pair of steel cables by means of oscillating metal joints placed at the upper corners. The panels can be freely fixed along the cables while the oscillating joints always maintain perfect verticality.

**F** Le système Tra light permet de suspendre les panneaux produits avec la technologie Snowsound à deux câbles en acier par des joints métalliques oscillants placés en correspondance des angles supérieurs. Les panneaux peuvent être fixés librement sur les câbles, tandis que les joints oscillants maintiennent toujours le panneau en position parfaitement verticale.

**D** Das System Tra light erlaubt es, die Paneele mit Snowsound-Technologie an einem Paar von Stahlseilen mittels von zwei schwingenden, an den oberen Kanten befindlichen Gelenkelementen zu befestigen. Die Platten können frei an den Seilen befestigt werden, während die schwingenden Gelenkelemente die Platte immer vertikal halten.

**E** El sistema Tra light permite suspender los paneles realizados con la tecnología Snowsound de una pareja de cables de acero mediante juntas metálicas oscilantes situadas enfrente de los ángulos superiores. Los paneles se pueden fijar libremente a lo largo de los cables, mientras las juntas oscilantes mantienen siempre la perfecta verticalidad del panel.



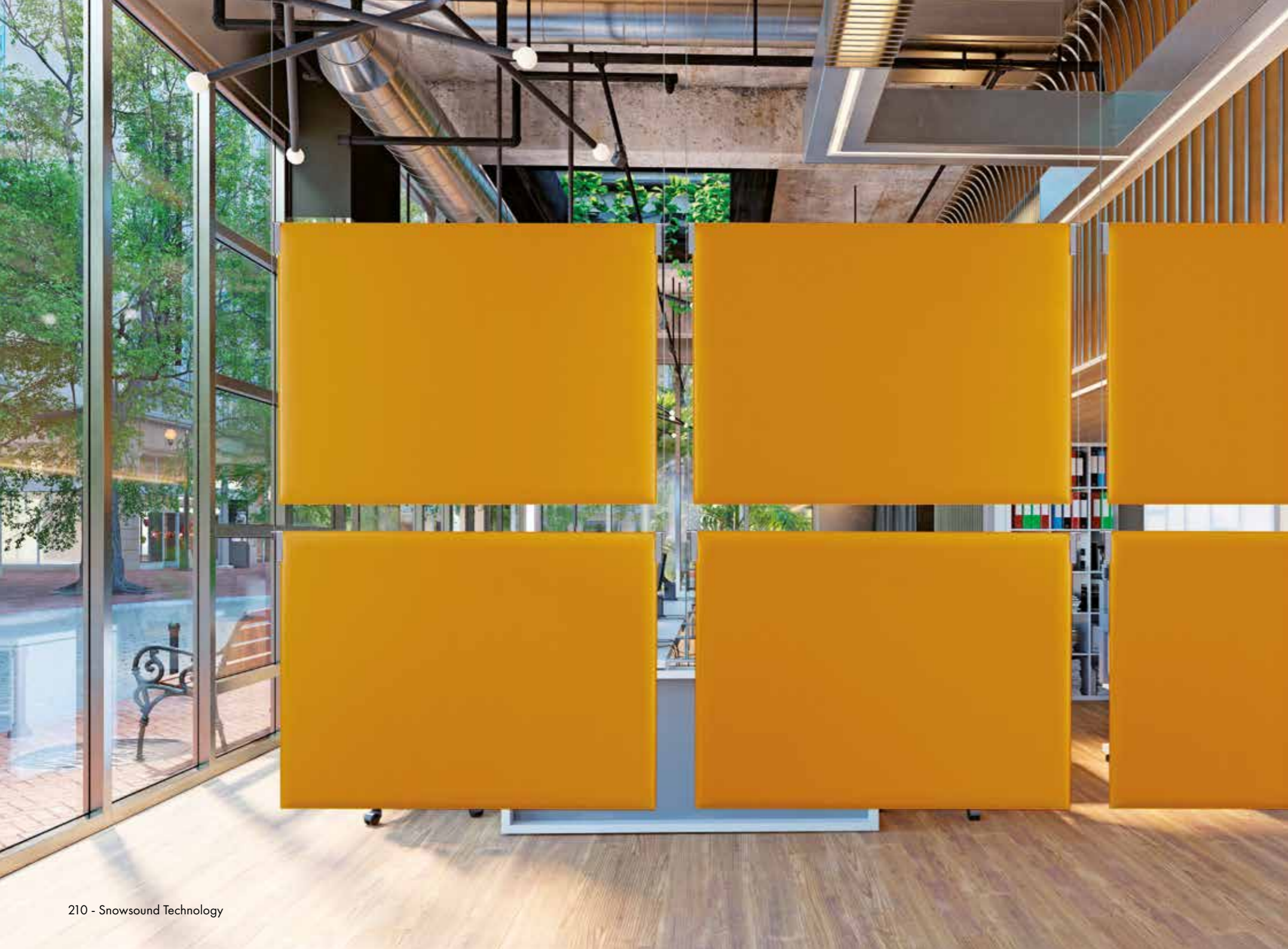

210 - Snowsound Technology



Tra light - 211

# TRA

## Marc Sadler



**I**\_Tra è un sistema brevettato composto da pannelli fonoassorbenti Snowsound sospesi ad una coppia di cavi in acciaio inossidabile che si collegano tra due pareti mantenendo una naturale curvatura. I cavi di sostegno possono essere posizionati con diverse inclinazioni. I pannelli Snowsound possono essere appesi ai cavi in varie posizioni, consentendo di ottenere composizioni sia esteticamente che acusticamente personalizzate.

**EN**\_Tra is a patented system consisting of Snowsound sound-absorbing panels suspended to a pair of stainless steel cables which are connected between two walls while maintaining a natural curve. The supporting cables can be positioned at a number of angles. Snowsound panels can be hung by cables in multiple positions, thereby creating compositions that can be personalised for aesthetics and sound.

**F**\_Tra est un système breveté composé de panneaux phono-absorbants Snowsound suspendus à une paire de câbles en acier inoxydable qui se relient entre deux parois en maintenant un cintrage naturel. Les câbles de suspension peuvent être positionnés selon différentes inclinaisons. Les panneaux Snowsound peuvent être suspendus aux câbles dans différentes positions, ce qui permet d'obtenir des compositions personnalisées aussi bien esthétiquement qu'acoustiquement.

**D**\_Tra ist ein patentiertes System, das aus schallabsorbierende Snowsound-Paneelen besteht, die mittels einem Paar Stahlseile, welches zwischen zwei Wänden gespannt wird, aufgehängt werden. Die Trageile können in verschiedenen Winkeln angebracht werden. Die Snowsound-Paneele können in vielen unterschiedlichen Positionen an den Stahlseilen aufgehängt werden, sodass man ästhetisch und akustisch gesehen personalisierte Lösungen erzielt.

**E**\_Tra es un sistema patentado compuesto por paneles fonoabsorbentes Snowsound que cuelgan de dos cables de acero inoxidable que se han tendido entre dos paredes manteniendo una curvatura natural. Los cables de sostén se pueden colocar con diferentes inclinaciones. Los paneles Snowsound se pueden colgar de los cables formando composiciones diferentes estéticamente y acústicamente personalizadas.



# PAGODA

## Caimi Lab



**I**\_Paralume fonoassorbente, la struttura in acciaio verniciato supporta due pannelli Snowsound disponibili in varie dimensioni. I pannelli sono disposti a falde inclinate distanziati tra loro per poter far passare le diverse sorgenti luminose. I cavi di sospensione sono regolabili in altezza.

**EN**\_Sound-absorbing lampshade that eventually doubles as a lampshade. The painted steel frame supports two Snowsound panels, available in various sizes. The panels are angled and spaced to allow the passage of different light sources between them. The suspension cables are height-adjustable.

**F**\_Abat-jour phono-absorbant qui peut être transformé en abat-jour. La structure en acier peint supporte deux panneaux Snowsound disponibles en plusieurs dimensions. Les panneaux sont disposés en pente, espacés les uns des autres pour permettre le passage des différentes sources de lumière. Les câbles de suspension peuvent être réglés en hauteur.

**D**\_Schallabsorbierendes Lampenschirm, das zu einem Lampenschirm werden kann. Die Struktur aus lackiertem Stahl trägt zwei Snowsound-Paneele, die in verschiedenen Größen erhältlich sind. Die Paneele sind schräg und in einem gewissen Abstand zueinander angeordnet, sodass verschiedene Lichtquellen hindurchgelassen werden können. Die Trageleine sind höhenverstellbar.

**E**\_Pantalla fonoabsorbente que se puede convertir en la pantalla de una lámpara. Su estructura de acero barnizado sostiene dos paneles Snowsound disponibles en diferentes tamaños. Los paneles están colocados de forma inclinada, con espacio entre sí para permitir el paso de la luz. La altura de los cables de sujeción es ajustable.



# IN

## Caimi Lab



**I** I pannelli Snowsound In con dimensione 59x59 cm oppure 59x119 cm possono essere inseriti all'interno di controsoffitti dotati di profili e supporti idonei al supporto degli stessi.

**EN** Snowsound In panels, measuring 59x59 cm or 59x119 cm, can be inserted in suspended ceilings with profiles and supports that can hold them.

**F** Les panneaux Snowsound In aux dimensions 59x59 cm ou 59x119 cm peuvent être insérés à l'intérieur de plafonds suspendus munis de profils et de supports aptes à les soutenir.

**D** Die Snowsound In-Paneele mit den Maßen 59x59 cm bzw. 59x119 cm können in Rasterdecken mit Profilen und geeigneten Halterungen eingehängt werden.

**E** Los paneles Snowsound In, con dos dimensiones, 59x59 cm y 59x119 cm, se pueden colocar dentro de los falsos techos con perfiles y soportes adecuados para su sostén.



# MIA

## Marta Martino



**I**\_Pannello fonoassorbente caratterizzato da un particolare drappeggio casuale del tessuto applicato a mano. Formato da un'anima interna con tecnologia Snowcustom e da un rivestimento esterno in tessuto acustico Snowsound Fiber 3 Melange.

**EN**\_Sound-absorbing panel characterized by a particular random draping of the fabric, handcrafted. Made up of an internal core with Snowcustom technology and an external covering in Snowsound Fiber 3 Melange acoustic fabric.

**F**\_Panneau phono-absorbant caractérisé par un drapage particulier et aléatoire du tissu appliqué manuellement. Il est formé par une âme interne avec technologie Snowcustom et un revêtement externe en tissu phono-absorbant Snowsound Fiber 3 Melange.

**D**\_Schallabsorbierendes Paneel, das sich durch eine spezielle, zufällige Drapierung des Gewebes auszeichnet, das von Hand aufgezogen wird. Bestehend aus einem mit Snowcustom-Technologie hergestellten Innenkern und einem äußeren Bezug aus akustischem Snowsound Fiber 3 Melange.

**E**\_Panel fonoabsorbente caracterizado por un particular drapeado del tejido, realizado a mano. Consta de una parte interior realizada con tecnología Snowcustom y de un revestimiento exterior en tejido acústico Snowsound Fiber 3 Melange.





# MITESCO

## Michele De Lucchi

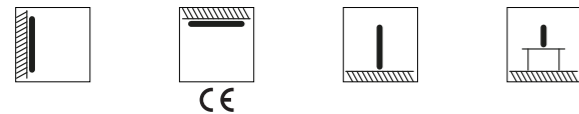

CE

**I**\_"La questione dell'acustica è molto complessa e per risolverla c'è bisogno di soluzioni estremamente semplici e non invasive. Il progetto sviluppato con Caimi è un pannello acustico che ha la dote di essere realizzato in un unico materiale, il poliestere, che alle ottime qualità di assorbimento aggiunge il fatto di essere completamente riciclabile, non avendo inclusioni di altri materiali. Il prodotto è leggero, colorato e sufficientemente "basic" da essere utilizzato anche per personalizzare l'ambiente, essendo inseribile appieno nei contesti contemporanei."

**EN**\_"The issue of acoustics is very complex, extremely simple and non-invasive solutions are needed to resolve it. The project developed with Caimi is an acoustic panel that is made with one single material, polyester, which in addition to its excellent absorbent qualities is completely recyclable, as it does not contain any other materials. Mitesco is light, colourful and sufficiently basic to be used even to personalize the surrounding area, as it can be fully inserted in a contemporary context."

**F**\_"La question de l'acoustique est très complexe et afin de la résoudre il faut des solutions extrêmement simples et non invasives. Le projet développé par Caimi est un panneau acoustique fait avec un seul matériel, le polyester, qui juxtapose aux excellentes qualités d'absorption le fait d'être entièrement recyclable, compte tenu qu'aucun autre matériel n'est prévu. Le produit est léger, coloré et suffisamment de base afin de l'utiliser pour personnaliser toute ambiance, compte tenu qu'il peut être utilisé pour meubler toute ambiance."

**D**\_"Das Thema Akustik ist sehr komplex, umso mehr bedarf es einfacher und unkomplizierter Lösungen. Das mit Caimi entwickelte Projekt ist ein akustisches Panel, das nur aus einem einzigen Material, Polyester, besteht, und sich daher neben seiner hervorragenden akustischen Eigenschaften dadurch auszeichnet, dass es komplett recyclebar ist. Das Produkt ist leicht, farbenfroh und unkompliziert genug um sogar zur individuellen Gestaltung der Umgebung verwendet zu werden, da es sich völlig in einen zeitgemäßen Kontext einfügt."

**E**\_"La cuestión de la acústica es muy compleja y para resolverla se necesitan soluciones muy simples y no invasivas. El proyecto desarrollado con Caimi es un panel acústico que tiene la dote de estar realizado con un único material, el poliéster, que a las óptimas características de absorción acústica añade el hecho de ser completamente reciclable, al no incluir otros materiales. El producto es liviano, de color y suficientemente "basic" para ser utilizado también para personalizar el ambiente, encajando perfectamente en los contextos contemporáneos."

(Michele De Lucchi)

Medtronic Italia, Milano (Italy)



## Mitesco magnetic

**I**\_Gli attacchi magnetici permettono, anche grazie alla leggerezza del pannello ed all'assenza di telai rigidi e spigolosi in alluminio o PVC (normalmente utilizzati in similari dispositivi fonoassorbenti), di applicare e di rimuovere facilmente i pannelli.

**EN**\_Magnetic connections make it easy to quickly apply or remove the panels. This is possible thanks to the lightness of the panel and the absence of rigid, sharp-edged aluminum/PVC frames (normally adopted in similar acoustic devices).

**F**\_Les connexions magnétiques permettent, grâce à la légèreté du panneau et à l'absence de cadres rigides ou coupants en aluminium ou en PVC (généralement utilisés pour des dispositifs similaires phono-absorbants), de fixer et enlever aisément les panneaux.

**D**\_Dank der Leichtigkeit des Paneels sowie dem Verzicht auf starre und kantige Rahmen aus Aluminium oder PVC (die normalerweise bei ähnlichen akustischen Elementen verwendet werden) ermöglichen die Magnetbefestigungen es, die Paneele einfach anzubringen und abzunehmen.

**E**\_Los enganches magnéticos permiten, también gracias a la liviandad del panel y al no tener bastidores rígidos y angulosos de aluminio o PVC (normalmente utilizados en dispositivos fonoabsorbentes similares), aplicar y remover fácilmente los paneles.



Technical Center (Japan)



## Mitesco wall | ceiling

**I**\_Il pannello fonoassorbente Mitesco è dotato di supporti che ne permettono il fissaggio a parete/soffitto. Il pannello fonoassorbente Mitesco può anche essere agganciato a chiodi/viti fissati nelle pareti mediante un gancio.

**EN**\_The sound-absorbing Mitesco panels has supports that allow it to be anchored to wall/ceiling. Mitesco sound-absorbing panels can be held in place by nails or screws anchored to walls with a hook.

**F**\_Le panneau phono-absorbant Mitesco est muni de supports qui permettent de le fixer aux paroi/plafond. Le panneau phono-absorbant Mitesco peut également être fixé à des clous ou à des vis fixés dans les murs, grâce à un crochet.

**D**\_Das schallabsorbierende Paneel Mitesco weist Halterungen auf, dank derer man es direkt an der Wand/Decke kann. Das schallabsorbierende Paneel Mitesco kann auch mit Hilfe eines Hakens durch Nägel oder Schrauben an der Wand befestigt werden.

**E**\_El panel fonoabsorbente Mitesco lleva soportes para fijación mural/techo. El panel fonoabsorbente Mitesco también se puede anclar, mediante un gancho, a clavos/tornillos clavados en las paredes.



AXA Assicurazioni, Milano (Italy)

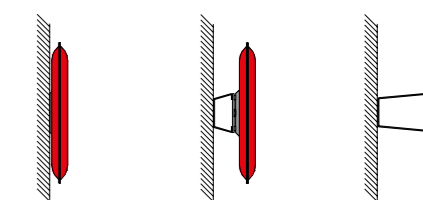
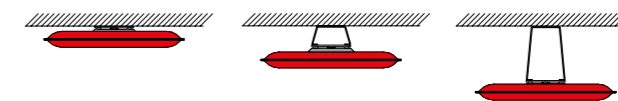

## Mitesco divider

**I** I divisori possono essere realizzati con pannelli posti su un solo lato o su due lati contrapposti, ottenendo così soluzioni fonoassorbenti esteticamente identiche su ambo i lati. Scegliendo nella gamma di colori disponibili, i pannelli Mitesco si possono combinare tra loro liberamente per ottenere mix cromatici interessanti e personalizzati.

**EN** The dividers can be realised with panels placed on one side only or on two opposing sides, thus obtaining sound absorbing solutions aesthetically identical on both sides. Choosing from a range of available colours, the Mitesco panels can be freely combined with each other to obtain interesting and customised colour mixes.

**F** Les cloisons peuvent être réalisés avec des panneaux sur un des côtés ou sur les côtés opposés, en profitant ainsi de solutions phono-absorbantes esthétiquement identiques de deux côtés. En choisissant dans la gamme des coloris disponibles, les panneaux Mitesco se peuvent juxtaposer librement afin d'obtenir des mix chromatiques intéressants et personnalisés.

**D** Die Paneele können als Raumteiler eingesetzt werden. Auf einer oder auf zwei gegenüberliegenden Seiten aufgestellt, werden damit ästhetisch ansprechende und akustisch wirksame Lösungen erzielt. Die Farben der Mitesco Paneele können frei untereinander kombiniert werden. Dadurch kann eine optisch ansprechende Farbgebung und Raumgestaltung erreicht werden.

**E** Los divisores pueden ser realizados con paneles colocados sobre un solo lado o sobre dos lados contrapuestos, logrando así soluciones fonoabsorbentes estéticamente idénticas. Eligiendo entre la gama de los colores disponibles, los paneles Mitesco se pueden combinar libremente entre ellos para lograr mezclas cromáticas interesantes y personalizadas.



## Mitesco totem

**I** Il gancio in alluminio lucido è un accessorio che permette di integrare nei totem fonoassorbenti Mitesco la funzione di appendiabiti in modo discreto ed elegante.

**EN** Mitesco sound-absorbing totems are incorporated with a glossy aluminum hook accessory to transform them into a discreet and elegant coat rack.

**F** Le crochet en aluminium poli est un accessoire qui permet d'intégrer dans les totems phono-absorbants Mitesco la fonction de portemanteau de manière discrète et élégante.

**D** Bei diesem Haken aus glänzendem Aluminium handelt es sich um ein Zubehör mit welchem man, auf diskrete und elegante Weise, das schallabsorbierende Totem Mitesco mit der Funktion eines Garderobenständers kombinieren kann.

**E** El gancho de aluminio brillante es un accesorio que complementa, de forma discreta y elegante, el totem fonoabsorbente Mitesco al emplearse como perchero.



## Mitesco desk

**I** Grazie a speciali staffe in acciaio verniciato i pannelli Mitesco possono essere appoggiati al piano, in questo modo è possibile cambiare rapidamente la configurazione del piano di lavoro.

**EN** Thanks to the special powder-coated steel brackets, Mitesco panels can be positioned on the desk quickly changing the layout of the work area.

**F** À travers des étriers spéciaux en acier peint, il est possible d'appuyer les panneaux Mitesco sur le dessus de façon qu'il soit possible de changer rapidement de configuration au niveau du plan de travail.

**D** Dank der speziellen Halterungen aus beschichtetem Stahl können die Mitesco Panele auf Oberflächen positioniert werden; dadurch wird die Möglichkeit gegeben, die Konfiguration der Arbeitsfläche zu ändern.

**E** Gracias a los soportes especiales de acero recubierto, los paneles Mitesco pueden ser apoyados en el plano; de esa manera es posible cambiar rápidamente la configuración del plano de trabajo.

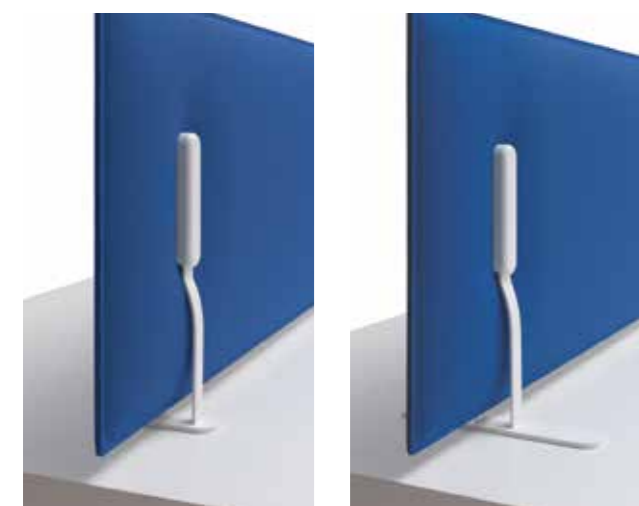

# MINIMAL

## Caimi Lab



**I** Il sistema Minimal consente di suddividere i piani di lavoro utilizzando pannelli realizzati con tecnologia Snowsound semplicemente inserendoli all'interno delle staffe. Gli attacchi Minimal, realizzati in fusione di metallo, sono caratterizzati dalla loro dimensione ridotta e dal design essenziale.

**EN** The system Minimal allows the subdivision of work surfaces using panels made with Snowsound technology by simply placing them inside the brackets. The brackets Minimal, made of cast metal, are characterized by their small size and essential design.

**F** Le système Minimal permet de subdiviser les surfaces de travail en utilisant des panneaux réalisés avec la technologie Snowsound simplement emboîtés dans des étriers. Les attaches Minimal, réalisées en fusion de métal, sont caractérisées par leurs dimensions réduites et par le design épuré.

**D** Das System „Minimal“ erlaubt es Arbeitsflächen zu unterteilen durch den Einsatz von Elementen mit Snowsound-Technologie, die einfach in Halterungen eingeführt werden. Die Befestigungen „Minimal“ aus Metallguss zeichnen sich durch geringe Größe und rationales Design aus.

**E** El sistema Minimal permite subdividir los planos de trabajo empleando paneles realizados con tecnología Snowsound que se introducen de forma sencilla en los soportes. Las fijaciones Minimal, realizadas en fusión de metal, se caracterizan por un tamaño reducido y un diseño esencial.





**I** Il sistema è disponibile con staffa per appoggio al piano della scrivania, per fissaggio diretto al piano o con morsetti.

**EN** The system is available with brackets for desk top stand, for direct fixing to the desk top or with clamps.

**F** Le système existe avec étriers à poser sur la surface du bureau, pour fixation direct sur la surface du bureau ou avec étaux.

**D** Das System ist mit Halterungen zur Aufstellung auf der Schreibtischfläche, zur Verschraubung direkt auf der Tischplatte oder mit Klemmen erhältlich.

**E** El sistema está disponible con soportes para sobremesa, para fijación directa al escritorio o con abrazaderas.

Peroni, Roma (Italy)



## CORNER

### Marc Sadler



**I**\_Il sistema Corner, che utilizza pannelli realizzati con la tecnologia Snowsound, è un'ottima soluzione per suddividere i piani di lavoro creando una barriera visiva ed ottimizzando il comfort acustico. Le ridotte dimensioni, associate ad una buona robustezza, sono il punto di forza degli attacchi Corner che permettono di applicare i pannelli Snowsound a scrivania mediante morsetti, direttamente al piano tramite viti oppure in appoggio.

**EN**\_Corner system, which uses Snowsound technology panels, is an ideal way to divide up work surfaces by creating a visual barrier while also optimizing acoustic comfort. A compact size, together with a robust construction, are the strengths of the mounting hardware that makes it possible to position Snowsound panels to the desk using clamps, screws or free-standing.

**F**\_Le système Corner utilise les panneaux réalisés avec la technologie Snowsound et offre une excellente solution pour répartir les plans de travail, en créant une barrière visuelle, et optimiser le confort acoustique. Les dimensions réduites associées à une bonne solidité sont le point fort des fixations Corner qui permettent d'appliquer les panneaux Snowsound au bureau à l'aide d'étaux ou directement au plan par des vis.

**D**\_Das System Corner, das mit Snowsound-Technologie hergestellte Paneele verwendet, bietet sich als eine ausgezeichnete Lösung um Arbeitsflächen zu trennen. Es können dabei visuelle Barrieren geschaffen und der akustische Komfort wesentlich verbessert werden. Kleine Maße, aber dennoch stabil - das sind die beiden Stärken, die die Halterungen von Corner auszeichnen. Sie gewährleisten Befestigung der Snowsound-Paneele mittels Klemmen am Schreibtisch oder anhand von Schrauben direkt an der Schreibtischfläche.

**E**\_El sistema Corner, que utiliza paneles realizados con tecnología Snowsound, es una excelente solución para dividir las superficies de trabajo, creando una barrera visual y optimizando el confort acústico. El tamaño compacto y la resistencia de los anclajes, permiten colocar los paneles en el escritorio mediante abrazaderas o directamente sobre la superficie con tornillos o de forma independiente.







# PLI DESK

## Marc Sadler



**I**\_I pannelli fonoassorbenti Pli possono essere utilizzati anche come divisori da appoggio a scrivania, garantendo comfort acustico, privacy e grande libertà di configurazione grazie alle cinghie elastiche che consentono l'unione dei pannelli con varie angolazioni e unioni a "T", ad "L" o ad "X".

**EN**\_Pli sound-absorbing panels can be also used as desk top partitions, thereby ensuring acoustic comfort, privacy and ultimate freedom of configuration thanks to the elastic straps that hold the panels together to create linear, "T", "L" or "X" formations.

**F**\_Les panneaux phono-absorbants Pli peuvent également être utilisés comme cloisons appuyés au bureau et garantir confort acoustique, discrétion et une grande liberté de configuration grâce aux courroies élastiques qui permettent d'unir les panneaux selon différents angles et assemblages en "T", en "L" ou en "X".

**D**\_Die schallabsorbierenden Paneele Pli können als Paravent auf Schreibtischen verwendet werden, wodurch akustischer Komfort, Ungestörtheit und absolute Gestaltungsfreiheit gewährleistet werden. Die elastischen Riemen halten die Paneele mit unterschiedlichen Neigungswinkeln sowie "T"-, "L"- oder "X"-förmig zusammen.

**E**\_Los paneles fonoabsorbentes Pli se pueden usar también como divisorio para el escritorio, garantizando confort acústico, privacidad y mucha flexibilidad de configuración gracias a las correas elásticas que enlazan los paneles con diferentes ángulos y uniones en "T", en "L" o en "X".



# SNOWFRONT

## Caimi Lab



**I**\_Snowfront permette il posizionamento dei pannelli al piano della scrivania tramite morsetti in metallo all'altezza desiderata.

**EN**\_Snowfront allows the panels to be positioned on the work surface using metal clamps at the desired height.

**F**\_Snowfront permet de poser les panneaux sur le plan du bureau à l'aide d'étau métalliques à la hauteur désirée.

**D**\_Anhand von Klemmen können die Snowfront-Paneele direkt an der Schreibtischfläche auf gewünschter Höhe angebracht werden.

**E**\_Con Snowfront se pueden sujetar los paneles a la superficie del escritorio tramite mordazas metálicas a la altura deseada.

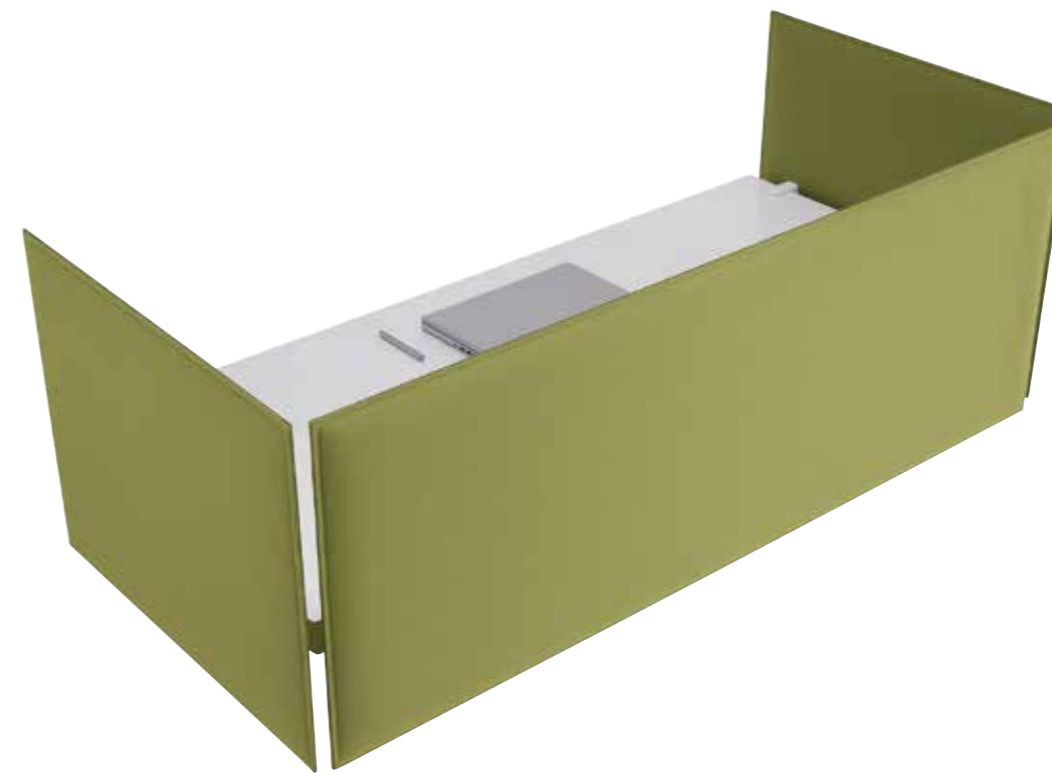

## OVERSIZE DESK

### Caimi Lab



**I**\_I pannelli Oversize fissati a scrivania garantiscono una maggiore privacy del posto di lavoro, consentendo anche una separazione degli spazi, nel rispetto di un buon comfort acustico.

**EN**\_Oversize panels fixed to desks ensure more privacy of the workplace, while also allowing a separation of spaces, in accordance with a good acoustic comfort.

**F**\_Les panneaux Oversize fixés au bureau garantissent plus de confidentialité au poste de travail et permettent de répartir l'espace, respectant un bon niveau de confort acoustique.

**D**\_Die an den Schreibtisch fixierbaren Oversize-Paneele bieten die Möglichkeit Arbeitsbereiche voneinander zu trennen und somit ein ruhigeres Arbeitsumfeld zu schaffen, ohne dabei den akustischen Komfort zu beeinträchtigen.

**E**\_Los paneles Oversize acoplados a escritorios garantizan una mayor privacidad del lugar de trabajo, permitiendo también una separación de los espacios, respetando un buen confort acústico.

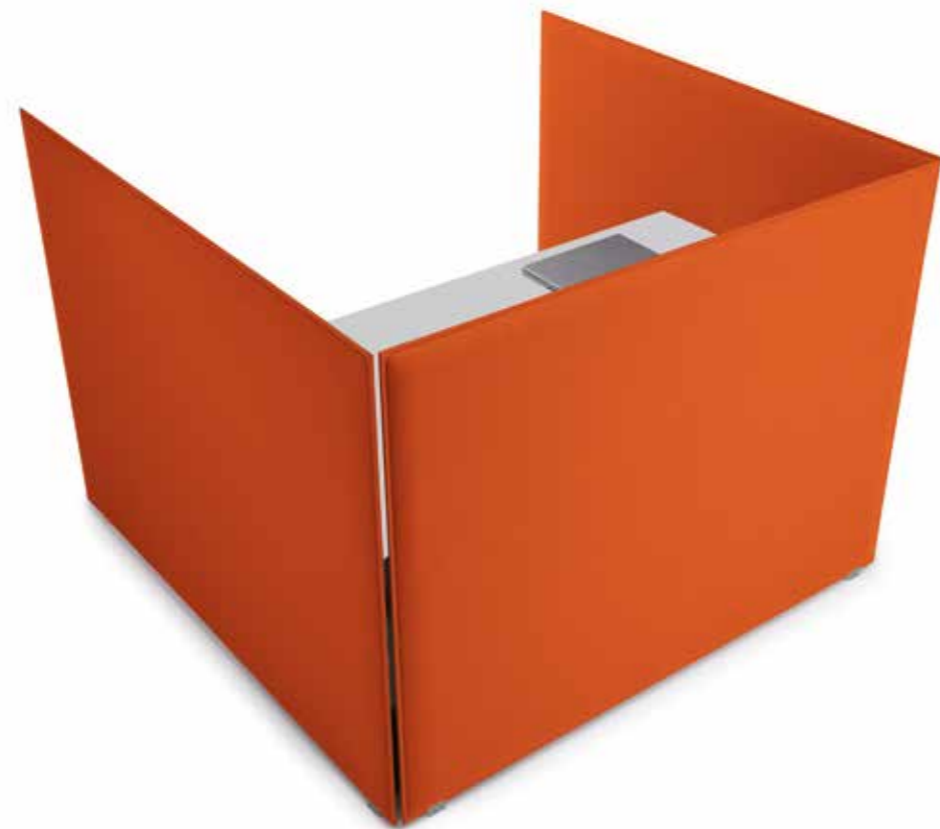

# BLADE

Lorenzo Damiani



**I**\_Blade è un sistema di mensole componibili in altezza che utilizza come schienale i pannelli fonoassorbenti realizzati con tecnologia Snowsound. Le sottili mensole rendono l'immagine complessiva dell'oggetto molto leggera e minimalista. Le mensole, interamente realizzate in acciaio verniciato, sono composte da un'anima portante fissata a parete e da un rivestimento esterno (piano d'appoggio) molto sottile.

**EN** Blade is a system, modular in height, whose back consists of sound-absorbing panels made with Snowsound technology. Slim shelves create a visually light and minimalist overall image. The shelves are entirely made in epoxy powder-coated steel: a wall-mounted load-bearing core and a very thin external lining (support surface).

**F**\_Blade est un système d'étagères à hauteur composable qui utilise pour fond les panneaux phono-absorbants réalisés avec la technologie Snowsound. Les étagères très fines confèrent à l'objet une image d'ensemble particulièrement légère et minimaliste. Entièrement réalisées en acier peint, ces étagères se composent d'une âme portante fixée au mur et d'un revêtement extérieur (plan d'appui) très mince.

**D**\_Blade ist ein Regalsystem, das eine beliebige Höhe erreichen kann. Die Rückwand besteht aus schallabsorbierenden Paneelen, die sich auf die Snowsound-Technologie stützen. Aufgrund der hauchdünnen Regalbretter wirkt das Regal leicht und schlicht. Die Regalbretter sind gänzlich aus lackiertem Stahl. In ihrem Inneren befindet sich eine an der Wand fixierte tragende Seele, während sie außen mit einer sehr dünnen Beschichtung (Ablagefläche) gefertigt sind.

**E** Blade es un sistema de estantes modulares en altura cuyo respaldo está compuesto por paneles fonoabsorbentes realizados con la tecnología Snowsound. Gracias a sus estantes delgados, la imagen del objeto en su conjunto es muy ligera y minimalista. Los estantes, de acero barnizado, constan de un elemento de soporte que se fija a la pared y un revestimiento exterior (superficie de apoyo) muy delgado.



## BEMOLLE

### Atelier Mendini



**I**\_Bemolle è un elemento fonoassorbente realizzato con struttura portante in acciaio e un drappo realizzato con tecnologia Snowsound Fiber. Questo “oggetto” ha nella sua parte alta un telaio in acciaio che consente al drappeggio di cadere assumendo precisi raggi e stratificazioni studiate per ottimizzare le performance acustiche.

**EN**\_Bemolle is a sound-absorbing element with steel base and drape based on Snowsound Fiber technology. This piece features steel frame at the top that create the sound-absorbing drape, thus assuming precise rays and layers, designed to optimise acoustic performance.

**F**\_Bemolle est un élément phono-absorbant réalisé avec une structure portante en acier et un drap fabriqué avec la technologie Snowsound Fiber. La partie haute de ce “objet” est faite de châssis en acier permettant un drapé qui suit des rayons et des stratifications étudiés en vue d’optimiser les performances acoustiques.

**D**\_Bemolle ist schallabsorbierend Element, die mit Stahlträger und Textilbezug, die sich auf die Snowsound Fiber-Technologie stützen, ausgestattet ist. Im oberen Teil haben diese “Objekte” Stahlprofile, die es den Textilbezug erlaubt, so zu fallen, dass sie präzise Radian und Schichtungen erzielen, die für eine optimale akustische Performance erforderlich sind.

**E**\_Bemolle es un elemento fonoasorbente realizado con estructura de soporte de acero y tela fabricada con tecnología Snowsound Fiber. Esto “objeto”, en la parte superior, tienen unos bastidores de acero para drapear la tela que cae con pliegues precisos y estratificaciones concebidas para optimizar el rendimiento acústico.



# PINNA

(a+b) Dominoni, Quaquaro



CE

**I** Struttura tridimensionale fonoassorbente che si dispiega a ventaglio con una curvatura suggerita dalle pieghe del tessuto plissettato e che ricorda la pinna di un grosso pesce. Pinna crea un dialogo tra saperi produttivi diversi; la tecnologia fonoassorbente dei tessuti Snowsound Fiber si fonde con le lavorazioni tessili provenienti dal settore moda. La struttura portante interna è in acciaio verniciato. Il sistema è sfoderabile.

**EN** Three-dimensional sound-absorbing structure, unfolding like a fan with a curvature that follows the pleats of the pleated fabric and which resembles the fin of a large fish. Pinna creates a dialogue between different productive knowledge; the sound-absorbing technology of the Snowsound Fiber fabrics blends with the textile processing from the fashion industry. The fabric slipcover is removable.

**F** Une structure tridimensionnelle phono-absorbante qui s'ouvre en éventail suivant la courbure des plis du tissu plissé et qui rappelle la nageoire d'un grand poisson. La nageoire crée un dialogue entre différents savoirs de la production; la technologie phono-absorbante des tissus Snowsound Fiber s'unit aux procédés de tissage provenant du secteur de la mode. La structure portante interne est en acier peint. Le tissu est amovible.

**D** Dreidimensionale Schalldämmstruktur, die sich fächerförmig in einer durch die Falten des plissierten Stoffes suggerierten Kurve wie die Flosse eines großen Fisches entfaltet. Pinna etabliert einen Dialog unter verschiedenen Produktionserfahrungen: Die Schalldämmtechnologie der Produkte Snowsound Fiber fließt mit den Textilverarbeitungstechniken aus der Modebranche zusammen. Die interne Tragstruktur ist aus lackiertem Stahl. Das System ist abziehbar.

**E** Estructura tridimensional fonoabsorbente que se despliega en abanico con una curvatura sugerida por las dobleces del tejido plisado que recuerda la aleta ("pinna") de un pez de grandes dimensiones. Pinna crea un diálogo entre conocimientos productivos de diversa índole; la tecnología fonoabsorbente de los tejidos Snowsound Fiber se fusiona con confecciones textiles provenientes del sector de la moda. La estructura de soporte interna es de acero barnizado. Sistema desenfundable.



# SI SBOCCIA

## Moreno Ferrari



CE

**I**\_Si Sboccia è un oggetto fonoassorbente realizzato con Snowsound Fiber, disponibile nella versione a parete o sospesa a soffitto. Una rosa di grandi dimensioni, nata dalla capacità del designer Moreno Ferrari di vedere oltre le cose: da un bocciolo di rosa trovato per caso, si è sviluppata l'idea di un prodotto utile ed emozionale al tempo stesso, in grado di arredare e caratterizzare gli ambienti rendendoli nel contempo acusticamente confortevoli.

**EN**\_Si Sboccia is a sound-absorbing object created with Snowsound Fiber, available for wall-mounting or ceiling suspension. Designer Moreno Ferrari's ability to see beyond mere objects has resulted in this large rose. From his fortuitous find of a rosebud, he came up with the idea of a product that is both useful and exciting, capable of decorating and characterizing environments while making them acoustically comfortable at the same time.

**F**\_Si Sboccia est un objet phono-absorbant réalisé avec Snowsound Fiber, disponible dans la version murale ou suspendue au plafond. Une rose de grandes dimensions, née grâce à la capacité du designer Moreno Ferrari de voir au-delà des choses : à partir d'un bouton de rose trouvé par hasard, est née l'idée d'un produit utile et émotionnel en même temps, en mesure de décorer et de personnaliser les intérieurs en assurant en même temps leur confort acoustique.

**D**\_Si Sboccia ist ein schallabsorbierendes Designobjekt mit Snowsound Fiber, das in einer Wand- oder Deckenversion erhältlich ist. Diese riesige Rose entspringt der Fähigkeit des Designers Moreno Ferrari hinter die bloßen Objekte zu blicken: Die Knospe einer Rose, die er zufällig fand, inspirierte ihn zu seiner Idee für ein Produkt, das nützlich und bezaubernd zugleich ist und das einen Raum einzigartig dekoriert und gleichzeitig für akustischen Komfort sorgt.

**E**\_Si Sboccia es un objeto fonoabsorbente realizado con Snowsound Fiber, hay un modelo mural y otro colgante para techo. Es una rosa de gran tamaño, que concibió el diseñador Moreno Ferrari: de un capullo de rosa que se plasmó al azar, se fue desarrollando la idea de un producto útil y también emotivo, que lograrse decorar y personalizar los ambientes ofreciendo, además, confort acústico.



Broadside Concept Sushi, Genova (Italy)





# COCKER

## Caimi Lab



**I**\_Cocker è un confortevole phone booth composto da un'imbottitura interna in poliester morbido e fonoassorbente, da un rivestimento in Snowsound Fiber completamente sfoderabile e da una struttura portante indipendente, realizzata in tondino d'acciaio cromato. I fianchi morbidi e mobili sono appositamente studiati per muoversi liberamente se urtati accidentalmente.

**EN**\_Cocker is a comfortable phone booth composed by an internal padding in sound-absorbing polyester foam covered in Snowsound Fiber which is completely removable. It also features an independent load-bearing frame in tubular chrome-plated steel. The soft, moveable sides have been specifically designed to move freely if accidentally bumped.

**F**\_Cocker est une cabine confortable composée d'un rembourrage interne en polyester souple et phono-absorbant, d'un revêtement en Snowsound Fiber entièrement amovible ainsi que d'une structure portante indépendante réalisée en tiges d'acier chromé. Les parois souples et mobiles ont été étudiées afin de bouger en toute liberté en cas de heurt accidentel.

**D**\_Cocker ist eine bequeme Telefonzelle, die innen mit weichem schalldämpfenden Polyester gepolstert ist und mit einem komplett abziehbaren Snowsound Fiber- Bezug verkleidet ist. Die unabhängige Struktur besteht aus verchromtem Rundstahl. Die weichen und beweglichen Seitenflächen wurden so gestaltet, dass sie nachgeben, wenn sie versehentlich angestoßen werden.

**E**\_Cocker es una confortable cabina acústica compuesta por un acolchado interior de poliéster suave y acústico absorbente, por un forro de Snowsound Fiber que se puede quitar por completo y por una estructura de sostén independiente, de hilo de acero cromado. Los lados blandos y móviles se concibieron específicamente para que se puedan mover libremente al chocar casualmente contra ellos.



# INDUSTRIAL

## Caimi Lab



**I**\_Linea di pannelli fonoassorbenti con elevate prestazioni acustiche (classe A di assorbimento acustico) studiati per essere accessibili anche per progetti su larga scala in ambito scolastico, commerciale ed industriale. Realizzati in poliestere a densità variabile, privi di rivestimento esterno e dotati di supporti che ne consentono il fissaggio a soffitto, in sospensione su cavi e a parete.

**EN**\_Collection of sound-absorbing panels with high acoustic performance (class A sound absorption), designed to be accessible even for large-scale projects in school, commercial and industrial settings. Made of variable density polyester, without external covering and equipped with supports that allow them to be fixed to the ceiling, to the wall or suspended through cables.

**F**\_Ligne de panneaux phono-absorbants aux performances acoustiques élevées (classe A d'absorption acoustique) étudiés pour être utilisés également pour des projets de grande envergure, dans les bâtiments scolaires, commerciaux et industriels. Réalisés en polyester a densité variable, sans revêtement externe et munis de supports qui permettent de les appliquer au plafond, en suspension sur des câbles et aux murs.

**D**\_Serie schallabsorbierender Panele mit hoher akustischer Leistung (Schallabsorptionsklasse A), die speziell für Großprojekte im Schul-, Gewerbe- und Industriebereich geeignet sind. Sie bestehen aus Polyester mit variabler Dichte, haben keinen äußeren Bezug und sind mit Halterungen ausgestattet, die eine Deckenmontage, Seilabhängung oder Wandmontage ermöglichen.

**E**\_Línea de paneles fonoabsorbentes con elevadas prestaciones acústicas (clase A de absorción acústica) específicamente diseñados para formar parte de proyectos de gran escala en los ámbitos educativo, comercial e industrial. Realizados en poliéster en densidad variable, no poseen revestimiento exterior y están dotados de soportes que permiten su fijación al techo, así como su colocación en suspensión con cables o en la pared.

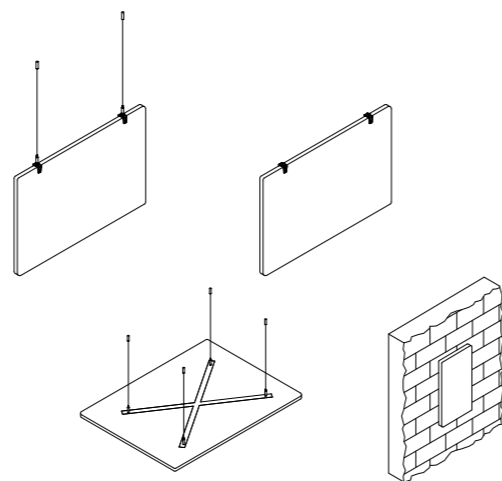



# Wall coverings

## Acoustic surfaces

**I** I rivestimenti murali Snowall e Snowall Maxi permettono di rivestire intere pareti garantendo un miglioramento acustico attraverso il trattamento di superfici anche di grandi dimensioni, sfruttando quindi una piacevole continuità visiva. L'esperienza tattile che rimanda al tessuto garantisce un feeling gradevole per una soluzione immediata sia nell'installazione che nella fruizione.

**EN** The Snowall and Snowall Maxi wall coverings allow entire walls to be covered, guaranteeing an acoustic improvement through the treatment of large surfaces, thus exploiting a pleasant visual continuity. The tactile experience that refers to a fabric grants a pleasant feeling for an immediate solution both in installation and use.

**F** Les revêtements muraux Snowall et Snowall Maxi permettent de recouvrir des murs entiers en garantissant une amélioration acoustique par le traitement de surfaces même importantes, en exploitant ainsi une agréable continuité visuelle. L'expérience tactile rappelant celle du tissu garantit une sensation agréable pour une solution immédiate tant au niveau de l'installation que de l'utilisation.

**D** Mit den Wandverkleidungen Snowall und Snowall Maxi können ganze Wände verkleidet werden, wodurch eine akustische Verbesserung durch die Behandlung auch großer Flächen gewährleistet wird und eine angenehme visuelle Kontinuität entsteht. Die taktile Erfahrung, die an Stoff erinnert, garantiert ein angenehmes Gefühl für eine sofortige Lösung sowohl bei der Installation als auch bei der Nutzung.

**E** Los revestimientos murales Snowall y Snowall Maxi permiten revestir paredes enteras, garantizando una mejora acústica mediante el tratamiento de grandes superficies, explotando así una agradable continuidad visual. La experiencia táctil que refiere un tejido otorga una sensación agradable para una solución inmediata tanto en la instalación como en el uso.

# SNOWALL

## Caimi Lab



**I** Snowall è un rivestimento composto da fibre di poliestere al quale viene applicato un tessuto Snowsound Fiber mediante un particolare sistema di fissaggio a caldo. Il rivestimento in tessuto delle fibre e l'assenza di intercapedini tra i due materiali, riducono notevolmente la possibilità di accumulare polveri, pollini o di ospitare insetti. Snowall è disponibile con rivestimento in tessuto Snowsound Fiber 3 Melange e Fiber 8 Bouclé. Snowall può essere facilmente incollato alla parete come una normale tappezzeria tessile.

**EN** Snowall is a covering composed of polyester fibres to which a Snowsound Fiber fabric is applied using a particular heating process. The covering fabric and the absence of airgaps between the two materials significantly reduce the possibility of dust and pollen accumulating dust, also preventing insect infestation. Snowall is available with Snowsound Fiber 3 Melange and Fiber 8 Bouclé fabric coverings. Snowall can be easily glued to the wall like normal textile wall covering.

**F** Snowall est un revêtement composé de fibres en polyester auquel est appliqué un tissu Snowsound Fiber grâce à un système particulier de fixation à chaud. Le revêtement en tissu des fibres et l'absence d'espace entre les deux matériaux réduit considérablement la possibilité d'accumuler de la poussière, du pollen ou d'abriter des insectes. Snowall est disponible avec le revêtement en tissu Snowsound Fiber 3 Melange et Fiber 8 Bouclé. Snowall peut être facilement collé au mur comme un normal revêtement textile.

**D** Snowall ist eine Verkleidung aus Polyesterfasern, auf die ein Snowsound Fiber-Gewebe mittels eines speziellen Wärmefixierungssystems aufgebracht wird. Der Bezug der Fasern mit Gewebe und die Tatsache, dass sich zwischen den beiden Materialien keine Hohlräume bilden, reduzieren die Möglichkeit der Ansammlung von Staub und Pollen oder die Ansiedlung von Insekten erheblich. Snowall ist mit Snowsound Fiber 3 Melange- und Fiber 8 Bouclé-Stoffbezug erhältlich. Snowall kann wie eine normale Textiltapete einfach an die Wand geklebt werden.

**E** Snowall es un revestimiento compuesto por fibras de poliéster al que se aplica un tejido fonoabsorbente Snowsound Fiber a través de un particular sistema de adhesión en caliente. El revestimiento textil de las fibras y la ausencia de huecos entre ambos materiales, reducen significativamente la posibilidad de que se acumule polvo, polen o insectos. Snowall está disponible en tejido Snowsound Fiber 3 Mélange y Fiber 8 Bouclé. Snowall puede pegarse fácilmente a la pared como cualquier tipo de papel pintado textil.



Fiber 8 Bouclé

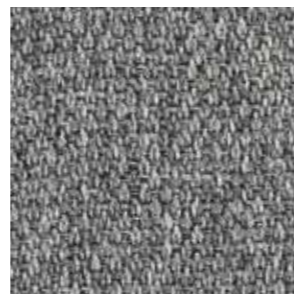

Fiber 3 Melange





262 - Wall coverings

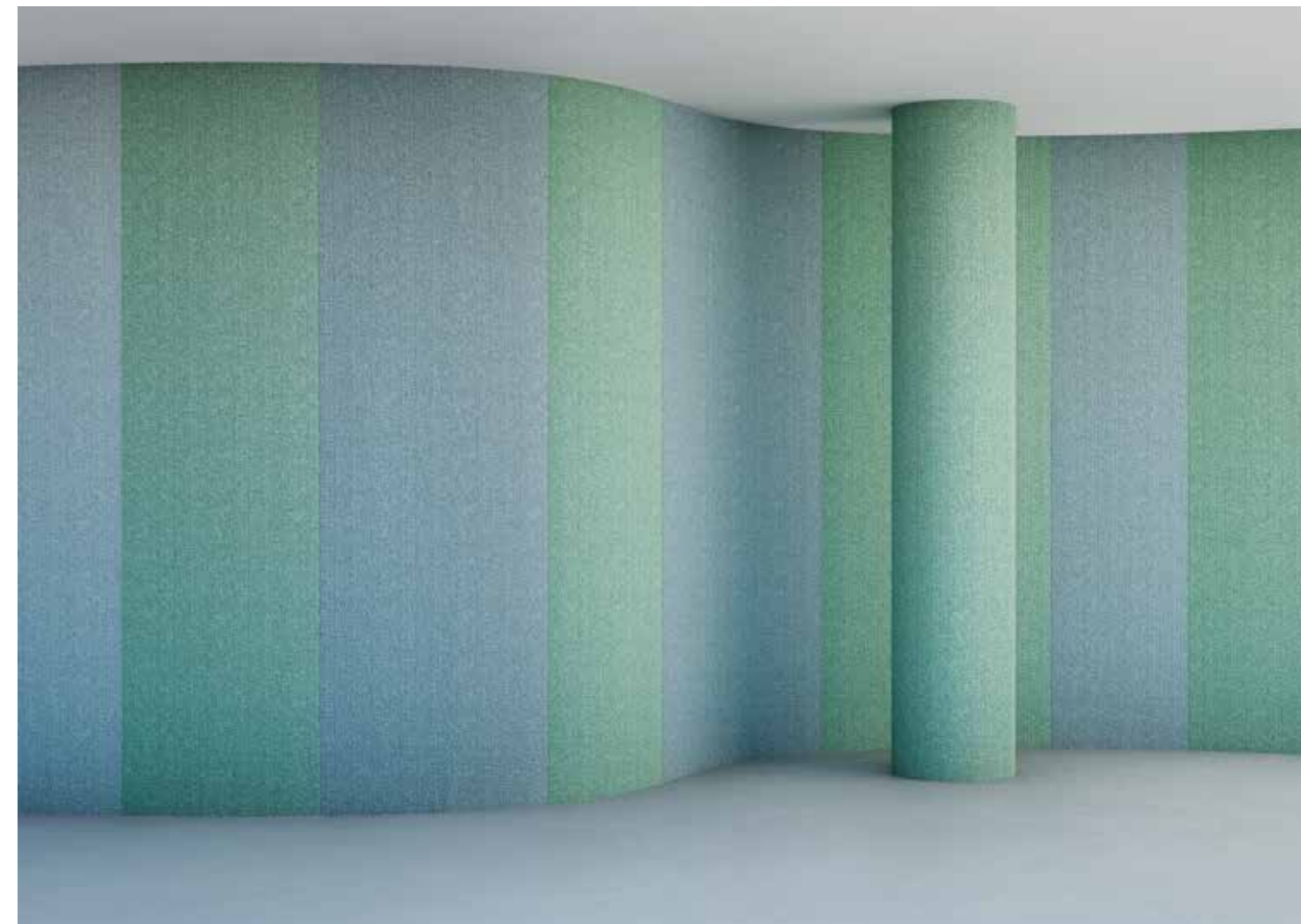

Snowall - 263



# SNOWALL MAXI

## Caimi Lab



**I** Pannelli fonoassorbenti flessibili applicabili a parete. I pannelli sono composti da fibre di poliestere ricoperte mediante un particolare sistema di fissaggio a caldo con un tessuto Snowsound Fiber 3 Melange. I pannelli possono essere incollati a parete affiancati uno all'altro mantenendo la continuità del disegno e possono essere tagliati in cantiere per adattarsi alle diverse esigenze di posa.

**EN** Flexible sound-absorbing panels applicable to walls. The panels are made of polyester fibers covered using a particular hot fixing system with a Snowsound Fiber 3 Melange fabric. The panels can be glued to the wall side by side, maintaining the continuity of the design and can be cut on site to adapt to different installation needs.

**F** Panneaux phono-absorbants souples applicables au mur. Les panneaux sont composés de fibres de polyester recouvertes de tissu Snowsound Fiber 3 Melange grâce à un système particulier de fixation à chaud. Les panneaux peuvent être collés au mur l'un à côté de l'autre en gardant la continuité du motif et peuvent être coupés sur place pour répondre aux différentes exigences de pose.

**D** Flexible schallabsorbierende Wandpaneele. Die Paneele bestehen aus Polyesterfasern, die mit einem speziellen Wärmefixierungssystem mit einem Snowsound Fiber 3 Melange-Gewebe überzogen werden. Die Paneele können nebeneinander an die Wand geklebt werden, um ein einheitliches Design zu schaffen, und lassen sich vor Ort zuschneiden, um sie an unterschiedliche Montageanforderungen anzupassen.

**E** Paneles fonoabsorbentes flexibles para colocar en la pared. Los paneles constan de fibras de poliéster revestidas mediante un especial sistema de fijación en caliente con tejido Snowsound Fiber 3 Melange. Los paneles pueden colocarse en la pared, unos al lado de otros, manteniendo la continuidad del diseño, o pueden cortarse en fábrica para amoldarse a las diversas necesidades de instalación.







# Snowsound Sofas & Tables

Acoustic furniture

**I** Divani, poltrone, pouf e tavolini fonoassorbenti progettati per migliorare con efficacia il benessere acustico negli ambienti, grazie all'impiego delle tecnologie e dei materiali Snowsound che testimoniano come l'acustica sia parte integrante del progetto arredo.

**EN** Sofas, armchairs, poufs and sound-absorbing coffee tables designed to effectively improve the acoustic wellbeing of indoor spaces. This is possible thanks to the use of Snowsound technologies and materials that confirm how acoustics is an integral part of the furniture project.

**F** Canapés, fauteuils, poufs et tables basses phono-absorbants conçus pour améliorer de manière efficace le confort acoustique dans les pièces, grâce à l'utilisation des technologies et des matériaux Snowsound qui montrent comment l'acoustique fait partie intégrante de la conception du mobilier.

**D** Schallabsorbierende Sofas, Sessel, Hocker und Beistelltische, die das akustische Wohlbefinden in Räumen dank der Verwendung von Snowsound-Technologien und -Materialien effektiv verbessern und die Bedeutung der Akustik als unerlässlicher Bestandteil des Einrichtungsprojekts belegen.

**E** Sofás, sillones, puffs y mesitas fonoabsorbentes, diseñados para mejorar de forma eficiente el bienestar acústico de los espacios, gracias al uso de las tecnologías y materiales Snowsound que demuestran el protagonismo de la acústica como parte integrante de los proyectos de decoración.



Download  
Snowsound Sofas  
brochure



Clicca e scarica  
il pdf.

Click and download  
pdf file.

# NAPWORK

## Paola Navone - Otto Studio



**A+E** optional  
Info pag. 22



Clicca e vai alla  
pagina selezionata.

Click and go to the  
selected page.

**I** “Moduli esagonali e lineari dall’immagine informale disegnano un sistema componibile di sedute imbottite acustiche che può non finire mai. Che sia in versione singola per allestire piccoli ambienti o multipla per grandi spazi comuni, dalla piccola lounge ai grandi ambienti, il sistema abbina il benessere acustico e il piacere di una seduta confortevole.”

**EN** “Hexagonal and linear modules with an informal image compose a modular system of acoustic upholstered seating, potentially never ending. Whether in its single version for a small rooms or as multiple pieces for large common areas, from the small lounge to large environments, the system combines acoustic wellbeing and the pleasure of a comfortable seat.”

**F** “Des modules hexagonaux et linéaires à l’image informelle qui créent un système modulaire de sièges phono-absorbantes qui pourrait ne jamais se terminer. Que ce soit en version unique pour les pièces plus petites ou en versions multiples pour les espaces communs, des petits salons aux grandes salles, le système allie le confort acoustique au plaisir d’une assise commode.”

**D** „Sechseckige und geradlinige Module mit zwanglosem Erscheinungsbild schaffen ein kombinierbares System von akustischen, gepolsterten Sitzgelegenheiten, das bis ins Unendliche reichen könnte. Ob in der Einzelversion für kleinere Räume oder aus mehreren Elementen für große Gemeinschaftsräume, von kleinen Lounges bis zu großen Flächen: Dieses System verbindet akustisches Wohlbefinden mit dem Genuss des bequemen Sitzens.“

**E** “Módulos hexagonales y lineales de aspecto informal componen un sistema modular de asientos acústicos, potencialmente infinitos. Tanto en su versión individual para decorar espacios pequeños o múltiple para grandes zonas comunes, desde un pequeño salón a grandes ambientes, el sistema combina el bienestar acústico con el placer de un cómodo asiento.”

(Paola Navone)





# VOLUMI

## Caimi Lab



**A+E** optional  
Info pag. 22



Clicca e vai alla  
pagina selezionata.

Click and go to the  
selected page.

**I**\_Collezione modulare di arredi fonoassorbenti connotata da linee visivamente squadrate ma di grande morbidezza al tocco, una fascia di tessuto color antracite nella parte inferiore crea un battitacco e un interessante gioco cromatico che accompagna tutti gli elementi. L'utilizzo ottimale del tessuto di copertura fonoassorbente Snowsound Fiber permette di raggiungere performance acustiche estremamente interessanti.

**EN**\_Modular collection of sound-absorbing furniture distinguished by visually squared lines but with great softness to the touch. A band of anthracite-coloured fabric in the lower part creates a sill and an interesting chromatic play that accompanies all the elements. The optimal use of the Snowsound Fiber sound-absorbing cover achieves excellent acoustic performance.

**F**\_Collection modulaire du mobilier phono-absorbants caractérisée par des lignes visuellement carrées mais avec une grande douceur au toucher, une bande de tissu de couleur anthracite à la base crée un contrefort et un jeu de couleurs intéressant qui accompagne tous les éléments. L'utilisation optimale du tissu de couverture phono-absorbante Snowsound Fiber permet d'obtenir des résultats acoustiques extrêmement intéressants.

**D**\_Eine modulare Kollektion von schallabsorbierenden Möbeln, die sich durch optisch kantige Linien auszeichnen, sich aber sehr weich anfühlen. Ein Band aus anthrazitfarbenem Stoff an der Unterseite bildet einen Trittschutz und ein interessantes Farbspiel, das sich durch alle Elemente zieht. Durch den optimalen Einsatz des schallabsorbierenden Bezugstoffes Snowsound Fiber wird eine äußerst überzeugende akustische Leistung erzielt.

**E**\_Colección modular de mobiliario fonoabsorbente caracterizada por líneas visualmente cuadradas pero suaves al tacto. La banda de tejido de color antracita de la parte inferior crea un marco reforzado y un interesante contraste cromático común a todos los elementos. El uso óptimo del tejido fonoabsorbente Snowsound Fiber permite alcanzar excelentes prestaciones acústicas.





**I**\_I divani e i pouf Volumi possono essere abbinati fra di loro per creare le configurazioni desiderate.

**EN**\_Volumi (sofas and poufs) can be mixed and matched to create different configurations.

**F**\_Les canapés et les poufs Volumi peuvent être combinés entre eux pour créer les configurations voulues.

**D**\_Volumi-Sofas und -Hocker können zu den gewünschten Konfigurationen zusammengestellt werden.

**E**\_Los sofás y puffs Volumi se pueden combinar entre sí para crear cualquier tipo de configuración.

# SNOWKING

## (a+b) Dominoni, Quaquaro



**A+E** optional  
Info pag. 22



Clicca e vai alla  
pagina selezionata.

Click and go to the  
selected page.

**I** "Più che un divano abbiamo pensato ad un personaggio silenzioso che occupa solennemente gli angoli, di solito spazi in cerca di destinazione, ed afferma una forte presenza scenica fornendo al contempo un prezioso contributo al benessere acustico della collettività. Quando si ritrova con altri elementi del suo casato si aggrega a formare isole, delimitare spazi, suggerire prospettive nobili come lui: Snowking!"

**EN** "More than a sofa, we thought about a silent character who solemnly occupies corners (that tend to be spaces looking for a purpose) and affirms a strong stage presence while providing a precious contribution to the acoustic wellbeing of the community. When he finds himself with other elements of his family, they join to form islands, delimiting spaces, suggesting noble perspectives just like him: Snowking!"

**F** "Nous n'avons pas tellement pensé à un canapé, mais plutôt à un personnage silencieux qui occupe solennellement des coins, généralement des espaces en quête de destination, et qui affirme une forte présence scénique tout en apportant une contribution précieuse au confort acoustique de la communauté. Quand il est réuni avec d'autres éléments de sa famille, il se regroupe avec eux, pour former des îlots, limiter des espaces ou ouvrir des perspectives aussi nobles que lui : Snowking!"

**D** "Mehr als an ein Sofa haben wir an eine stille Figur gedacht, die feierlich Ecken - die meist auf der Suche nach einer Bestimmung sind - einnimmt und eine starke szenische Präsenz aufweist, wobei sie gleichzeitig einen wertvollen Beitrag zum akustischen Wohlbefinden der Allgemeinheit leistet. Wenn er mit anderen Elementen seiner Familie vereint ist, formt er Inseln, grenzt Räume ab und bietet Perspektiven, die so edel sind wie er selbst: das ist der Snowking!"

**E** "Más que en un sofá, hemos pensado en un personaje silencioso que ocupa solemnemente los rincones -que suelen ser espacios que buscan un propósito-, y asegura una fuerte presencia escénica, al tiempo que contribuye al bienestar acústico de la comunidad. Cuando se encuentra con otros elementos de su familia, se pueden unir para formar islas, delimitando espacios y sugiriendo nobles perspectivas como él: ¡Snowking!"

(Annalisa Dominoni, Benedetto Quaquaro)





**I** I due elementi che compongono i divani Snowking possono essere abbinati fra loro per creare le configurazioni desiderate.

**EN** Snowking sofas consist of two elements that can be combined in different ways to create the requested configurations.

**F** Les deux éléments qui composent les canapés Snowking peuvent être combinés entre eux pour créer les configurations voulues.

**D** Die beiden Elemente, aus denen die Snowking-Sofas bestehen, können zu den gewünschten Konfigurationen zusammengestellt werden.

**E** Los dos elementos que componen los sofás Snowking pueden combinarse entre sí para crear tantas configuraciones como se desee.





## CILINDRO

Claudio Bellini



**I**“Una struttura geometrica, sintesi di un incastro di volumi e forme essenziali. Intersezioni analitiche di punti, linee e superfici, iscritte in una seduta acustica di ispirazione modernista.”

**EN**“A geometric structure, synthesis of an interlocking of volumes and essential shapes. Analytical intersections of points, lines and surfaces, inscribed in an acoustic seat of modernist inspiration.”

**F**“Une structure géométrique, synthèse de l'union de volumes et de formes essentielles. Des intersections analytiques de points, lignes et surfaces, inscrites dans un siège acoustique qui s'inspire de l'époque moderniste.”

**D**„Eine geometrische Struktur, eine Synthese aus ineinandergreifenden Volumen und essentiellen Formen. Analytische Überschneidungen von Punkten, Linien und Flächen in einer akustischen Sitzfläche modernistischer Inspiration.“

**E**“Una estructura geométrica, síntesis del entrelazado de volúmenes y formas esenciales. Una intersección analítica de puntos, líneas y superficies, inscrita en un asiento acústico de inspiración modernista.”

(Claudio Bellini)





286 - Snowsound Sofas & Tables



Cilindro - 287

# SNOWSOFA

## Sezgin Aksu



**I**\_Snowsofa è un divano acustico a schienale alto pensato per garantire un comfort a tutto tondo nei momenti di pausa e di relax, fondendo comodità, ergonomia e benessere acustico in un unico oggetto d'arredo. La tenda arricciata che caratterizza l'oggetto è realizzata con tessuto acustico Snowsound Fiber.

**EN**\_Snowsofa is an acoustic, high back sofa, designed to offer all-round comfort during breaks merging ease ergonomics and acoustic wellbeing in a single piece of furniture. The pleated curtain that characterizes this product is manufactured using Snowsound Fiber acoustic fabric.

**F**\_Snowsofa est un canapé acoustique avec dossier haut conçu pour garantir un confort total pendant les moments de pause et de détente, assurant confort, ergonomie et bien-être acoustique en un seul meuble. Le rideau plissé qui caractérise l'objet est réalisé avec le tissu acoustique Snowsound Fiber.

**D**\_Snowsofa ist eine akustische Couch mit hoher Rückenlehne, die dazu entwickelt wurde, sich in Momenten der Ruhe und Entspannung rundum wohl zu fühlen. Es vereint Bequemlichkeit, Ergonomie und akustischen Komfort in einem einzigen Möbelstück. Der Plisse-Vorhang, durch den sich der Einrichtungsgegenstand auszeichnet, besteht aus dem akustisch wirksamen Stoff Snowsound Fiber.

**E**\_Snowsofa es un sofá acústico con respaldo alto concebido para garantizar un confort total en los momentos de pausa y de relax, acoplando comodidad, ergonomía y bienestar acústico en un objeto de decoración único. La cortina fruncida que caracteriza este objeto se realizó con tela de absorción acústica Snowsound Fiber.



# SNOWPOUF

Paola Navone - Otto Studio



**I**\_Confortevoli elementi fonoassorbenti rivestiti con tessuto Snowsound Fiber 3 Melange, composti da un'imbottitura interna in tecnopolimeri fonoassorbenti e materiale ligneo. La collezione Snowpouf comprende pouf di varie dimensioni e un tavolino con piano d'appoggio in legno di rovere chiaro.

**EN**\_Comfortable sound-absorbing objects covered with Snowsound Fiber 3 Melange fabric and, internally, consisting of technopolymer sound-absorbing padding and wood. Snowpouf collection includes poufs of various sizes and a coffee table with light oak wood top.

**F**\_Éléments phono-absorbants confortables, revêtus avec le tissu Snowsound Fiber 3 Melange, composés d'un rembourrage interne en technopolymères phono-absorbants et matériel en bois. La collection Snowpouf se compose de poufs de différentes dimensions et une table basse avec plateau de table en bois de chêne clair.

**D**\_Komfortables schallabsorbierendes Element, bezogen mit Snowsound Fiber 3 Melange-Gewebe, bestehend aus einer Innenpolsterung aus schallabsorbierenden Technopolymeren und Holzmaterial. Die Snowpouf-Kollektion besteht aus Hockern in verschiedenen Größen und einem Beistelltisch mit einer Platte aus hellem Eichenholz.

**E**\_Confortables elementos fonoabsorbentes, tapizados con tejido Snowsound Fiber 3 Melange, compuestos con un relleno de tecnopolímeros fonoabsorbentes y material derivado de la madera. La colección Snowpouf incluye puf de varias medidas y una mesita de café con tablero de madera de roble claro.





**I**\_Snowpouf può essere facilmente spostato tramite un'elegante fettuccia realizzata in tessuto.

**EN**\_An elegant fabric ribbon helps users pull Snowpouf into the desired position.

**F**\_Snowpouf est facile à déplacer grâce à une sangle élégante en tissu.

**D**\_Snowpouf lässt sich mit einem eleganten Gurtband aus Stoff leicht bewegen.

**E**\_Snowpouf se puede desplazar fácilmente gracias a una elegante cinta de tela.





**I**\_Snowpouf nella versione un posto, due posti ovale e tavolino, è ora disponibile anche rivestito nei nuovi tessuti Snowsound Fiber 12 ECONYL®. (vedi pag. 58)

**EN**\_Snowpouf in the one-seater, two-seater oval and coffee table versions, is now also available covered in the new Snowsound Fiber 12 ECONYL® fabrics. (see page 58)

**F**\_Snowpouf dans la version à une place, deux places ovale et petit table, est maintenant disponible revêtu avec les nouveaux tissus Snowsound Fiber 12 ECONYL®. (Voir page 58)

**D**\_Snowpouf ist in den Ausführungen als Einsitzer, ovaler Zweisitzer und Beistelltisch jetzt auch mit den neuen Snowsound Fiber 12 ECONYL®-Bezügen erhältlich. (Siehe Seite 58)

**E**\_En las versiones de una plaza, dos plazas, ovalado y mesita, Snowpouf se propone también tapizado con los nuevos tejidos Snowsound Fiber 12 ECONYL®. (Ver pag. 58)



## FULCRO

Claudio Bellini



**I**\_Tavolini disponibili in varie dimensioni e finiture. Il fusto portante è realizzato con le tecnologie fonoassorbenti Snowsound.

**EN**\_Coffee tables available in a variety of sizes and finishes. The base features Snowsound sound-absorbing technologies.

**F**\_Tables basses disponibles en différentes dimensions et avec différents finissages. La base est produite en utilisant les technologies phono-absorbantes Snowsound.

**D**\_Beistelltische in verschiedenen Größen und Ausführungen. Die Basis ist mit schallabsorbierenden Snowsound-Technologien gefertigt.

**E**\_Pequeñas mesas disponibles en diversos tamaños y acabados. La base está realizada con tecnologías fonoabsorbentes Snowsound.



# LUCREZIO

## Caimi Lab



**I** Un innovativo sistema di tavoli fonoassorbenti, disponibili in versione tonda e ovale con piani di molte dimensioni, per soddisfare le diverse esigenze estetiche e funzionali. La struttura interamente in acciaio verniciato con polveri epossidiche ha un'originale forma a clessidra realizzata in tondini stretti da una fascia nella parte centrale che crea due figure coniche, una superiore e una inferiore: entrambe ospitano al loro interno elementi fonoassorbenti rivestiti in tessuto acustico Snowsound Fiber 3 Melange, disponibile in un'ampia gamma di colori.

**EN** An innovative system of sound-absorbing tables, available in round and oval versions with tops of many sizes, meant to satisfy different aesthetic and functional needs. The structure, entirely in epoxy powder-coated steel has an original hourglass shape made of narrow rods, which creates two conical figures (upper and lower). Both are filled with sound-absorbing elements, covered with Snowsound acoustic fabric Fiber 3 Melange, available in a wide range of colours.

**F** Un système innovant de tables phono-absorbants, disponibles en version ronde et ovale avec des plateaux de plusieurs dimensions, pour répondre aux différentes exigences esthétiques et fonctionnelles. La structure est entièrement en acier peint avec des poudres époxy, possède une forme originale de sablier et est composée de tiges d'acier, serrées par une bande dans la partie centrale pour créer deux figures coniques, l'une supérieure et l'autre inférieure : les deux abritent à l'intérieur des éléments phono-absorbants, recouverts par du tissu acoustique Snowsound Fiber Textiles 3 Melange, disponible dans une vaste gamme de couleurs.

**D** Ein innovatives System von schallabsorbierenden Tischen, erhältlich in runder und ovaler Ausführung mit Tischplatten in vielen verschiedenen Größen, um unterschiedlichen ästhetischen und funktionalen Anforderungen gerecht zu werden. Die vollständig aus epoxidpulverbeschichtetem Stahl bestehende Struktur hat eine originelle Sanduhrform, bestehend aus Stäben, die durch ein Band in der Mitte zusammengezogen werden, was zwei konische Figuren bildet, eine obere und eine untere: Beide beinhalten schallabsorbierende Elemente, die mit Akustikstoff Snowsound Fiber 3 Melange überzogen sind, das in einer breiten Farbpalette erhältlich ist.

**E** Un innovador sistema de mesas fonoabsorbentes, disponibles en formato redondo u ovalado con tableros de diferentes tamaños para responder a las distintas necesidades estéticas y funcionales. La estructura, íntegramente realizada en acero barnizado con polvos epoxi, tiene una original forma de reloj de arena creada con un conjunto de varillas ceñidas por una banda central y creando dos figuras cónicas en la parte superior e inferior. Ambas formas albergan elementos fonoabsorbentes revestidos de tejido acústico Snowsound Fiber Textiles 3 Melange, disponible en una amplia paleta de colores.

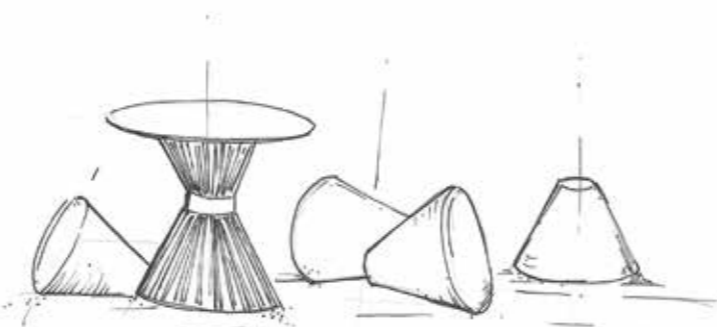





**I** I piani in materiale composito sono realizzati con struttura a "sandwich", costituita da un'anima in MDF racchiusa tra due lastre in alluminio, rivestite nella parte superiore e sui bordi perimetrali in cemento applicato e spazzolato a mano. Il carattere artigianale della lavorazione dei piani rende ogni pezzo unico ed esclusivo nella finitura e nel colore.

**EN** The composite material tops are made with a "sandwich" structure, consisting of an MDF core enclosed between two aluminium plates, covered on the upper part and on the perimeter edges with brushed cement (handmade). The artisanal nature of the workmanship of the tops makes each piece unique and exclusive in finish and colour.

**F** Les plateaux en matériau composite sont réalisés avec une structure en « sandwich », formée par une âme en MDF placée entre deux plaques d'aluminium, revêtues dans la partie supérieure et sur les bords en béton brossé à la main. Le caractère artisanal de la réalisation des plateaux rend chaque pièce unique et exclusive en termes de finition et de couleur.

**D** Die Tischplatten aus Verbundmaterial weisen eine „Sandwich“-Struktur auf, bestehend aus einem MDF-Kern zwischen zwei Aluminiumblechen, die auf der Oberseite und an den Rändern mit handaufgetragenem und handgebürstetem Zement beschichtet sind. Die handwerkliche Verarbeitung der Platten macht jedes Stück einzigartig und exklusiv in Ausführung und Farbe.

**E** Los tableros de material compuesto están realizados con una estructura tipo sándwich con un alambre de MDF encastrado entre dos láminas de aluminio revestidas en la parte superior y en los laterales con aplicaciones de cemento cepillado a mano. El carácter artesanal de la elaboración de estos tableros convierte cada ejemplar en una pieza única y exclusiva, tanto en acabado como en color.



**Watch the top manufacturing process**



Clicca e guarda il video.

Click and watch the video.



# Snowsound Art

**I** Snowsound Art è un progetto di Caimi che ha come obiettivo un viaggio alla scoperta di nuove strade per far dialogare ARTE e DESIGN. Un modo di vedere l'arte, non solo come una creazione unica, non ripetibile, ma come una "bellezza" riproducibile su oggetti seriali. L'arte non solo da contemplare, l'arte da fruire. Nel 2020 due opere di Gillo Dorfles sono entrate a far parte della collezione permanente di Arte e Design del Quirinale (Residenza del Presidente della Repubblica Italiana).

**EN** Snowsound Art is a Caimi project that aims to be a journey of discovery, looking for new ways to bring ART and DESIGN together. A way of interpreting art not just as a unique creation that can't be repeated, but as a form of beauty that can be reproduced on serial objects. Art isn't just to be contemplated. It is to be enjoyed as well. In 2020, two designs by Gillo Dorfles were added to the permanent Art and Design collection at the Italian President's official residence in Rome, the Quirinale Palace.

**F** Snowsound Art est un projet de Caimi proposant un voyage à la découverte de nouvelles voies pour établir un dialogue entre l'ART et le DESIGN. Une manière de voir l'art non seulement comme une création unique, non répétable, mais comme une "beauté" reproductible sur des objets en série. L'art non seulement destiné à être contemplé, mais à être utilisé. En 2020 deux œuvres de Gillo Dorfles ont intégré la collection permanente de Art et Design du Quirinal (la résidence du Président de la République italienne).

**D** Snowsound Art ist ein Projekt von Caimi als Entdeckungsreise auf der Suche nach neuen Wegen mit dem Ziel, Kunst und Design zusammenzuführen. Dabei wird Kunst nicht nur als einmalige, unwiederholbare Schöpfung betrachtet, sondern als "Schönheit", die auf einer Reihe von Produkten reproduzierbar wird. Eine Kunst, die nicht nur bestaunt werden, sondern auch genutzt werden kann. Im Jahr 2020 wurden zwei Werke von Gillo Dorfles in die ständige Sammlung für Kunst und Design des Quirinale (Residenz des Präsidenten der Italienischen Republik) aufgenommen.

**E** Snowsound Art es un proyecto de Caimi: un viaje que permite explorar nuevos caminos que compaginan ARTE y DISEÑO. Una forma de concebir el arte que no solo es una creación única e irrepitable, sino también una "belleza" replicable en objetos en serie. Un arte que se admira al tiempo que se disfruta. En 2020 dos obras de Gillo Dorfles entraron a formar parte de la colección permanente de Arte y Diseño del Palacio del Quirinale (la residencia del Presidente de la República Italiana).



**Download  
Snowound Art  
brochure**



Clicca e scarica  
il pdf.

Click and download  
pdf file.



UNTITLED, 1937-2017, Sound-absorbing Snowsound Art panel, 119 x 159 cm. Palazzo del Quirinale. Sala del Plastico, "Senza titolo 1991" di Gillo Dorfles, foto Massimo Listri 2020, su concessione del Segretario Generale della Presidenza della Repubblica.

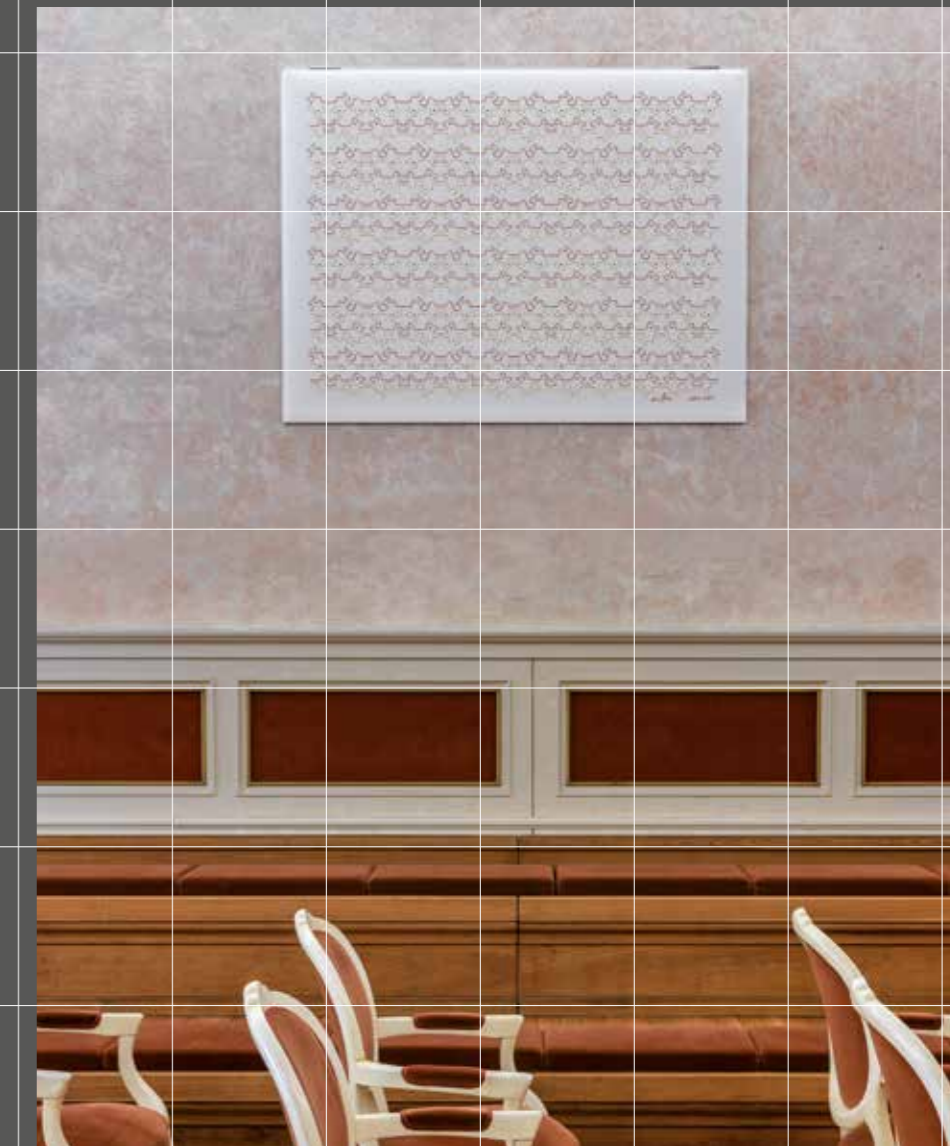

UNTITLED, 1937-2017, Sound-absorbing Snowsound Art panel, 119 x 159 cm. Tenuta Presidenziale di Castelporziano, "Senza titolo 1937-2017" di Gillo Dorfles, foto Massimo Listri 2020, su concessione del Segretario Generale della Presidenza della Repubblica.

# GIO PONTI

Lo splendore del futuro | The Splendor of future

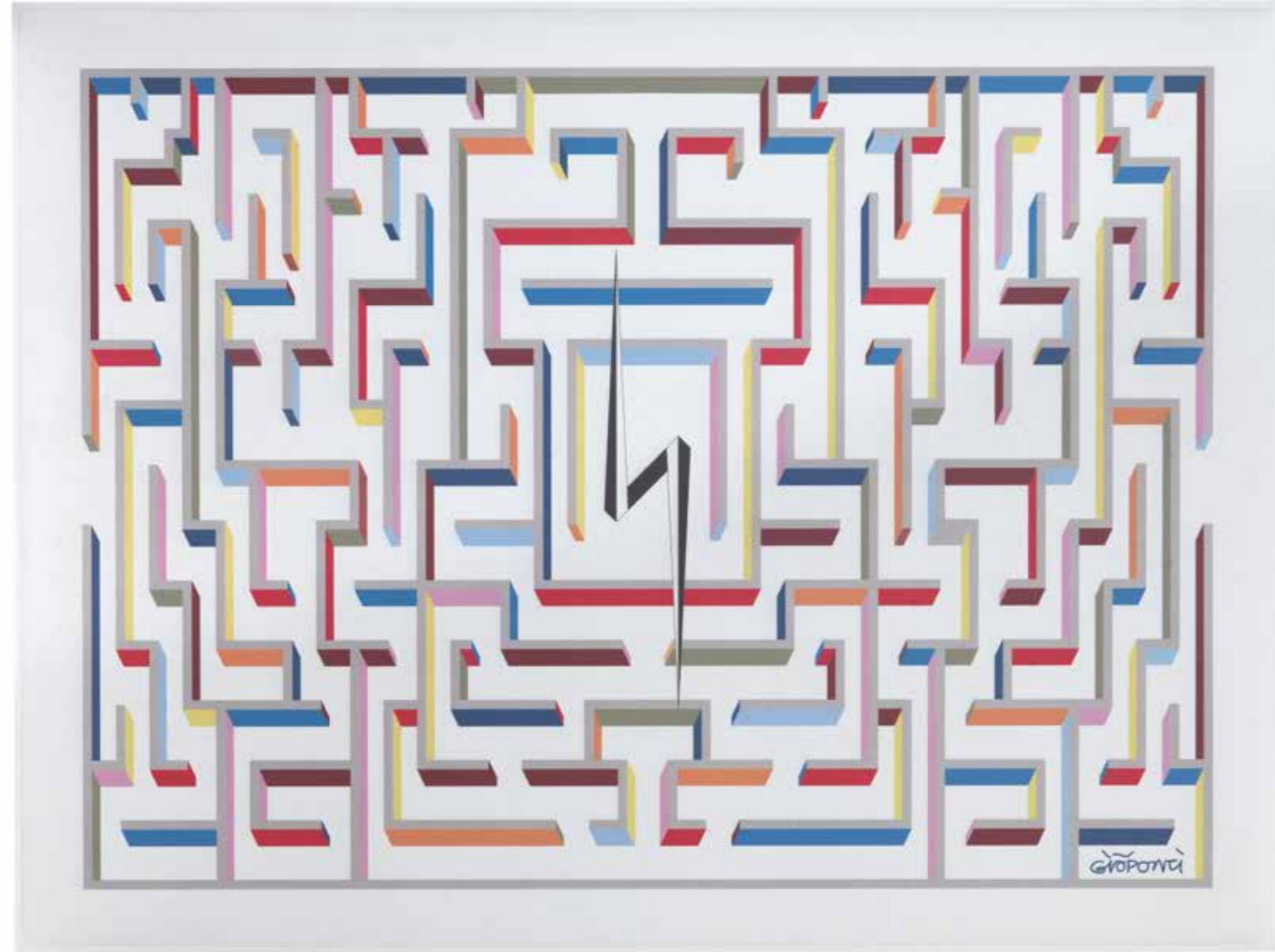

**LABYRINTH, 1941-1947**  
Sound-absorbing Snowsound Art panel,  
119 x 159 cm



**PAINTED DOORS, 1957**  
Sound-absorbing Snowsound Art panel,  
159 x 59 cm



**SUPERGATTOMAGGIORE, 1967**  
Sound-absorbing Snowsound Art panel,  
59 x 59 cm



**DRAWN LETTERS**  
Sound-absorbing Snowsound Art panel,  
75 x 59 cm

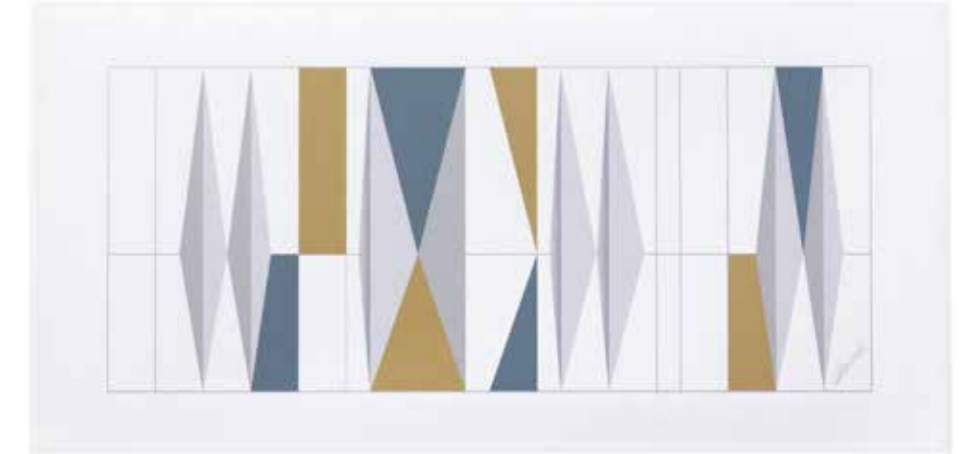

**DECOR FOR VILLA PLANCHART AND VILLA NEMAZEE, 1955-1964**  
Sound-absorbing Snowsound Art panel,  
59 x 119 cm



**DRAWN LETTERS**  
Sound-absorbing Snowsound Art panel,  
59 x 59 cm



Clicca e scarica il pdf.

Click and download pdf file.

**Download Snowound Art brochure**



# GILLO DORFLES

Per un gigantismo del disegno | Enormous design

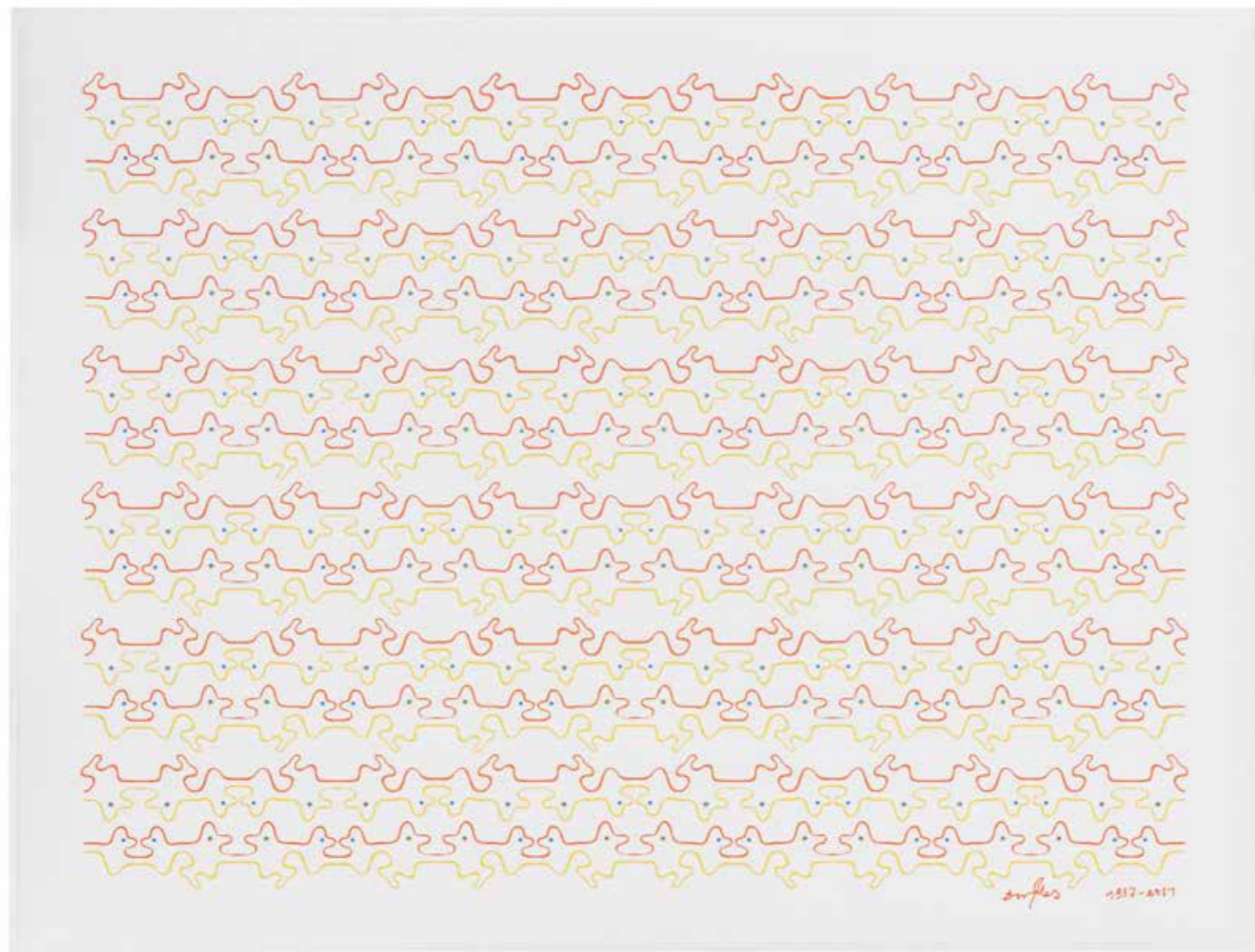

**UNTITLED, 1937-2017**  
Sound-absorbing Snowsound Art panel,  
119 x 159 cm



Clicca e scarica  
il pdf.

Click and download  
pdf file.

**Download  
Snowound Art  
brochure**



**UNTITLED, 1998**  
Sound-absorbing Snowsound Art panel,  
119 x 119 cm



**UNTITLED, 1955-2017**  
Sound-absorbing Snowsound Art panel,  
159 x 119 cm

**UNTITLED, 1991**  
Sound-absorbing Snowsound Art panel,  
159 x 119 cm

# ALESSANDRO MENDINI

Le idee e le cose | Ideas, things

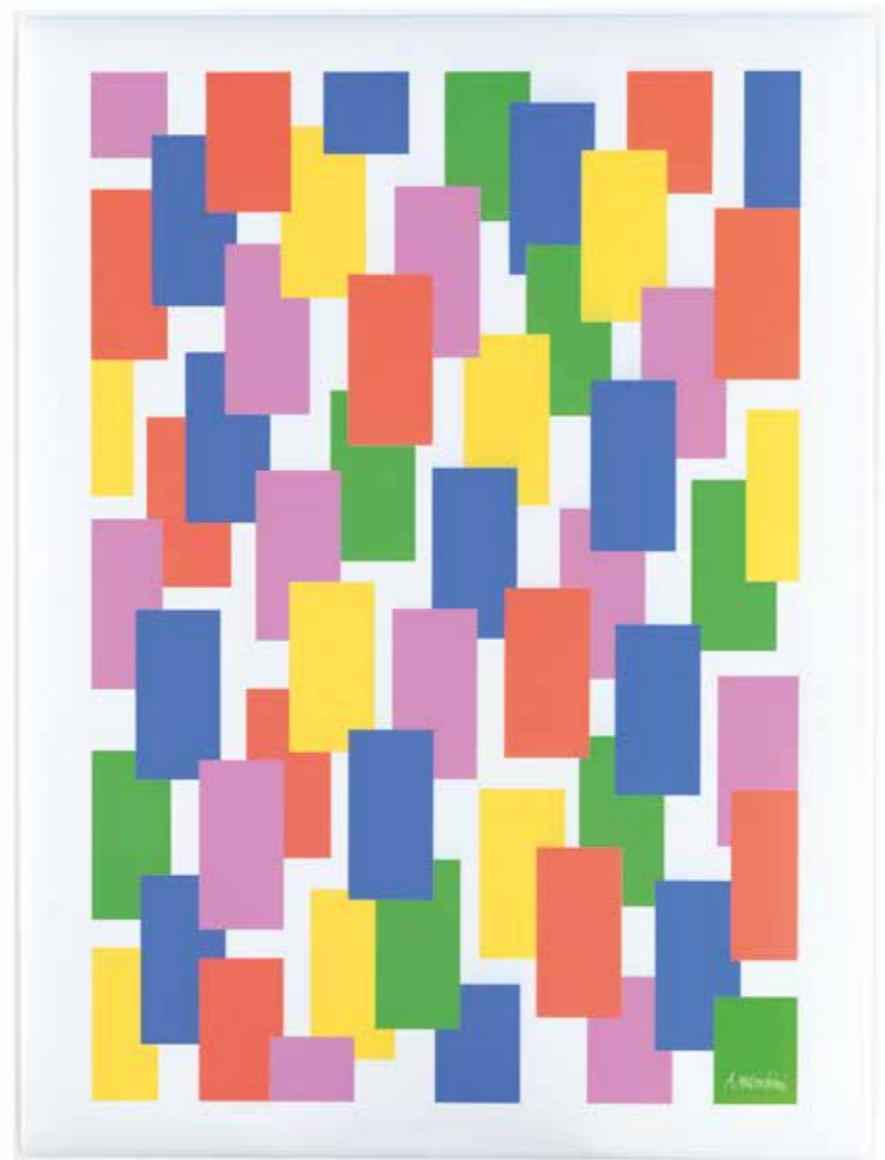

**PROUST**  
Sound-absorbing Snowsound Art panel,  
159 x 119 cm



**OLLO**  
Sound-absorbing Snowsound Art panel,  
75 x 59 cm



**RIMATARA**  
Sound-absorbing Snowsound Art panel,  
59 x 59 cm



**SIC**  
Sound-absorbing Snowsound Art panel,  
159 x 119 cm



Clicca e scarica  
il pdf.

Click and download  
pdf file.

**Download  
Snowound Art  
brochure**



# MARIO TRIMARCHI

Silenzio | Silence



Clicca e scarica  
il pdf.

Click and download  
pdf file.

**Download  
Snowound Art  
brochure**



**PEONIA**  
Sound-absorbing Snowsound Art panel,  
ø 117 cm



**IRIS**  
Sound-absorbing Snowsound Art panel,  
ø 117 cm

**PAPAVERO**  
Sound-absorbing Snowsound Art panel,  
ø 117 cm



# SEZGIN AKSU

## Un design indiziario | Design clues



Clicca e scarica il pdf.

Click and download pdf file.

**Download  
Snowound Art  
brochure**



**LINES, 2019**  
Sound-absorbing Snowsound Art panel,  
159 x 119 cm

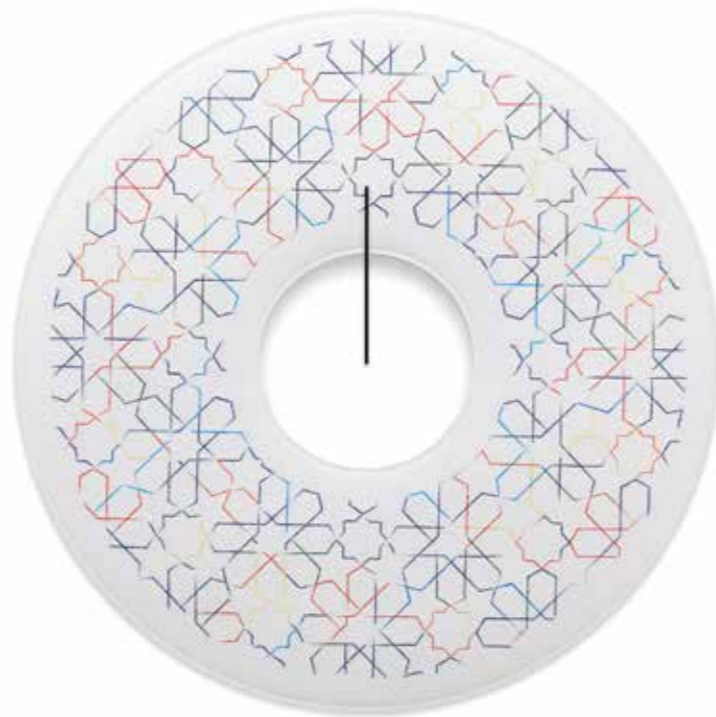

**OTTOMAN, 2019**  
Sound-absorbing Snowsound Art panel,  
ø 119 cm



**NATURE, 2019**  
Sound-absorbing Snowsound Art panel,  
159 x 119 cm

# Projects



Clicca e vai alla pagina selezionata.

Click and go to the selected page.

316 **Offices & Call centers**

320 **Public spaces & Museums**

322 **Education & Schools**

324 **Healthcare**

326 **Retail & Leisure**

328 **Restaurants, Cafes & Hotels**

332 **Home**

334 **Audio & Music**



**Download  
projects  
brochure**



Clicca e scarica il pdf.

Click and download pdf file.



## OFFICES & CALL CENTERS



BMW Financial Service, Milano (Italy)



BPER Banca, Modena (Italy)



Office, design by AECOM, Los Angeles (U.S.A)



Nasdaq OMX, Paris (France)



Microsoft (Italy)



Tangram Interiors, Los Angeles (U.S.A.)



Criteo, Milano (Italy)



Hjelle, Oslo (Norway)



Peroni, Roma (Italy)



Download  
projects  
brochure



Clicca e scarica  
il pdf.  
Click and download  
pdf file.

# OFFICES & CALL CENTERS



Convey, Miramar (U.S.A.)



SONY, CBRE Building, Chicago (U.S.A.)



Sky, Milano (Italy)



Rapt Studio, San Francisco (U.S.A.)



Xerox (Italy)



Belimo (Germany)



Würth Elektronik Italia, Vimercate MB (Italy)



Fincontatto, Napoli (Italy)



Gensler, Miami (U.S.A.)



Download  
projects  
brochure



Clicca e scarica  
il pdf.

Click and download  
pdf file.

## Public spaces & Museums



American Airlines (U.S.A.)



Centre d'Affaires Greenbizz, Bruxelles (Belgium)



MAXXI, Roma (Italy)



Seville Aéroport (Spain)



Tech Lab, Amsterdam (Netherlands)



Fondazione Arnaldo Pomodoro, Milano (Italy)



Merchandise Mart, Chicago (U.S.A.)



MUMAC, Binasco MI (Italy)



DNK, Assen (Netherlands)



Download  
projects  
brochure



Clicca e scarica  
il pdf.

Click and download  
pdf file.

## Education & Schools



Università Bocconi, Milano (Italy)



Babson College, Jeddah (Saudi Arabia)



International School of Europe, Milano (Italy)



Universitat Central de Catalunya, Barcelona (Spain)



Business School, London (UK)



Politecnico di Milano (Italy)



Student House, Dresden (Germany)



University of Miami (U.S.A.)



Download  
projects  
brochure



Clicca e scarica  
il pdf.

Click and download  
pdf file.

# Healthcare



Fondazione Umberto Veronesi (Italy)



Hôpital de Vannes (France)



Ospedale San Giuseppe, Empoli (Italy)



Hsr Hospital, Milano (Italy)



Casa di cura Parco dei Tigli, Padova (Italy)



IEO, Milano (Italy)



Ospedale di Perugia (Italy)



Download  
projects  
brochure



Clicca e scarica  
il pdf.  
Click and download  
pdf file.

## Retail & Leisure



Autosalone, Terni (Italy)



Stiz, taglio e colore, Rovereto TN (Italy)



Garage, Fargo (U.S.A.)



Personaltraining studio, Reggio Emilia (Italy)



Gioielleria De Giorgio (Italy)



Download  
projects  
brochure



Clicca e scarica  
il pdf.  
Click and download  
pdf file.

## Restaurants, Cafes & Hotels



Print Restaurant, New York (U.S.A.)



Identità Golose, Milano (Italy)



45° parallelo, Sabbioneta MN (Italy)



Dal Corso, Verona (Italy)



Starbuks, Chicago (U.S.A.)



Fragranze pizzeria, Chieti (Italy)



AIM restaurant, Loosdrecht (Netherlands)



Hotel Belvedere, Riccione (Italy)

Alla Piazza Koya, Ravenna (Italy)



Download  
projects  
brochure



Clicca e scarica  
il pdf.

Click and download  
pdf file.

## Restaurants, Cafes & Hotels



La Virgule, Chauray (France)



Cottura 9, Genova (Italy)



Sky, Milano (Italy)



Vanilla Caffè & Cucina, Finale Emilia MO (Italy)



Beardslee Public House, Washington State (U.S.A.)



Fourghetti, Bologna (Italy)



Arnoldo Mondadori Editore, Segrate MI (Italy)



Tre Farine, Aversa CE (Italy)



Download  
projects  
brochure



Clicca e scarica  
il pdf.

Click and download  
pdf file.





# Home



Private house (Netherlands)



Private house, Milano (Italy)



Private house (Germany)



Private house (U.S.A.)



Private house, Pelican Lake (U.S.A.)



Private house, Napoli (Italy)



Private house, Zwolle (Netherlands)



Private house, Roma (Italy)



Private house, Nebraska (U.S.A.)



**Download  
projects  
brochure**



Clicca e scarica  
il pdf.

Click and download  
pdf file.

## Audio & Music



Theater, Lido di Venezia (Italy)



CTRL, Los Angeles (U.S.A.)



RAI broadcasting studio (Italy)



Radio Yacht, Capri NA (Italy)



WOM By Audio Visual Group, Las Vegas (U.S.A.)



New Horizon School (U.S.A.)



Download  
projects  
brochure



Clicca e scarica  
il pdf.

Click and download  
pdf file.



# SNOWSOUND FIBER TEXTILES

**I** La tecnologia brevettata Snowsound Fiber è basata su morbide fibre acustiche di poliestere intrinsecamente ignifughe e interconnesse tra loro. L'interazione tra le fibre di Snowsound Fiber e l'aria permette di controllare il riverbero regolando con precisione la risposta acustica dell'ambiente in base alle modalità di posa, alla superficie e alla distanza tra le fibre e la parete, consentendo di ridurre il fastidioso riverbero acustico negli ambienti, migliorando la qualità della vita e del lavoro.

**EN** The patented Snowsound Fiber technology is based on soft interwoven polyester acoustic fibers that are inherently fire-resistant. The interaction between Snowsound Fiber and air allows controlling reverberation while adjusting the environment's acoustics with precision taking advantage of installation modes, product's surface and distance from the wall. This reduces the annoying acoustic reverberation improving quality both of life and of work.

**F** La technologie brevetée Snowsound Fiber se base sur des fibres acoustiques très souples de polyester entrelacées et intrinsèquement ignifuges. L'interaction entre les fibres de Snowsound Fiber et l'air permet de contrôler la réverbération en réglant avec précision la réponse acoustique de l'espace selon la méthode d'installation, la surface et la distance entre les fibres et le mur. Ainsi faisant on réduit la réverbération acoustique fastidieuse de la pièce en améliorant donc la qualité de vie et du travail.

**D** Die patentierte Technologie Snowsound Fiber basiert auf weichen, akustischen, innerlich feuerfesten und eng miteinander verbundenen Polyester-Fibern. Die Interaktion zwischen Snowsound Fiber und der Luft erlaubt es, den Widerhall zu kontrollieren und die akustische Antwort des Raums auf der Grundlage des Verlegungsmodus, der Fläche und der Distanz zwischen Fibern und Wand präzise zu regulieren, und somit den störenden Widerhall von Räumen zu verringern und dadurch die Lebens- und Arbeitsqualität zu verbessern.

**E** La tecnología patentada Snowsound Fiber se basa en suaves fibras acústicas de poliéster entrelazadas, intrínsecamente resistentes al fuego. La interacción entre Snowsound Fiber y el aire permite controlar la reverberación mientras ajusta la acústica del entorno con precisión, aprovechando los modos de instalación, la superficie del producto y la distancia desde la pared. Esto atenúa la molesta reverberación acústica en los ambientes, mejorando la calidad de la vida y del trabajo.



**Download technologies brochure**



Clicca e scarica il pdf.

Click and download pdf file.

**Snowsound software**

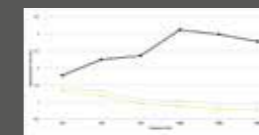

**Decibels reduction "Rw index"**



**Research & patents**



**Acoustic performance**

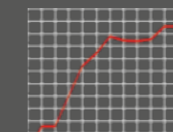

**Greenguard Gold**



**Eco-friendly**



**No formaldehyde**



**Fire resistance**

Fiber 1, 2, 2R, 3, 6, 7, 8



# SNOWSOUND TECHNOLOGY

**I**\_La brillante intuizione alla base della tecnologia brevettata Snowsound è l'utilizzo di pannelli composti da materiale a densità variabile, che permette di ottenere un assorbimento selettivo alle diverse frequenze e quindi di ottimizzare l'acustica dell'ambiente nonostante lo spessore molto contenuto dei pannelli. L'assenza di cornici e cuciture e la peculiarità del materiale con cui sono realizzati i pannelli, li rendono estremamente leggeri, poco ingombranti e adattabili ad ogni ambiente.

**EN**\_The brilliant intuition at the heart of Snowsound patented technology is based on the use of panels composed of material with variable density, which achieve selective absorption at different frequencies and thus optimise the acoustical environment notwithstanding the thinness of the panels. The absence of frames and seams and the unusual characteristics of the material used in the fabrication of the panels, render them extremely light, unobtrusive and adaptable to any environment.

**F**\_La brillante intuition à la base de la technologie brevetée Snowsound pré-voit l'emploi des panneaux en particules à densité variable, qui permet d'obtenir une absorption sélective aux différentes fréquences et par conséquent d'optimiser l'acoustique des espaces, malgré l'épaisseur très mince des panneaux. L'absence de cadres et de coutures et la spécificité du matériel de base en font des panneaux très légers, peu encombrants et qui s'adaptent très bien à tout espace.

**D**\_Die Grundlage der patentierten Snowsound Technologie besteht aus der Verwendung von Materialien unterschiedlicher Dichte. Diese Materialien absorbieren die unterschiedlichsten Frequenzbereiche und ermöglichen trotz geringer Materialstärke eine Verbesserung der Raumakustik. Die Snowsound Paneele sind, ohne Rahmen oder Nähte, aus einem Stück gefertigt, besonders leicht und passen sich an jedes Ambiente an.

**E**\_La brillante intuición a la base de la tecnología patentada Snowsound es el uso de paneles compuestos por materiales de densidad variable, que permite obtener una absorción selectiva en las diversas frecuencias y entonces optimizar la acústica del ambiente, a pesar del espesor muy reducido de los paneles. La ausencia de marcos y costuras y la peculiaridad del material con el que son realizados los paneles, lo vuelven muy livianos, poco voluminosos y adaptables para todos ambientes.

**1** **I**\_Le superfici del pannello sono rivestite in tessuto di poliestere Trevira CS® solidamente applicato all'imbottitura interna con la quale forma un corpo unico senza soluzione di continuità. Proprietà che permette di ottenere una superficie che, pur essendo visivamente molto soft, risulta essere resistente, difficile da strappare e da perforare.

**EN**\_The surfaces of the panel are coated with Trevira CS® polyester fabric firmly bonded to the inner wadding with which it forms a single body without a break. This property makes it possible to obtain a surface which, while visually appearing very soft, actually is resistant, difficult to tear or perforate.

**F**\_Les surfaces du panneau sont recouvertes en tissu en polyester Trevira CS® bien fixé au rembourrage interne avec lequel il forme un corps unique sans solution de continuité. Il s'agit d'une caractéristique qui permet d'obtenir une surface qui, bien qu'étant du point de vue visuel très soft, est très résistante, difficile à arracher et percer.

**D**\_Die Oberfläche der Paneele werden mit Trevira CS® beschichtet. Dieser Stoff aus Polyester wird mit dem Paneel zu einem Element verbunden und bildet mit diesem eine Einheit. Die Oberfläche sieht weich und angenehm aus dennoch ist das Paneel äußerst widerstandsfähig und kann nur sehr schwer eingerissen oder durchbohrt werden.

**E**\_Las superficies del panel están tapizadas en tejido de poliéster Trevira CS® firmemente aplicada al relleno interno con el cual forma un cuerpo único, sin solución de continuidad. Propiedad que permite obtener una superficie que, aún siendo visualmente muy soft, resulta ser resistente, difícil de arrancar y perforar.

**2** **I**\_Poliestere ad alta densità.

**EN**\_High density polyester.

**F**\_Polyester à haute densité.

**D**\_Polyester mit hoher Dichte.

**E**\_Poliéster de alta densidad.

**3** **I**\_Poliestere a media densità.

**EN**\_Medium density polyester.

**F**\_Polyester à moyenne densité.

**D**\_Polyester mit mittlerer Dichte.

**E**\_Poliéster de mediana densidad.

**4** **I**\_Poliestere a bassa densità.

**EN**\_Low density polyester.

**F**\_Polyester à basse densité.

**D**\_Polyester mit niedriger Dichte.

**E**\_Poliéster de baja densidad.

**5** **I**\_Bordo rigido.

**EN**\_Rigid edge.

**F**\_Bord rigide.

**D**\_Feste Kante.

**E**\_Borde rígido.

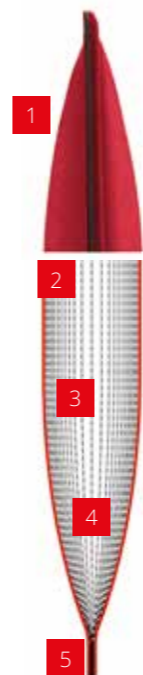

**Download technologies brochure**



Clicca e scarica il pdf.

Click and download pdf file.

**Snowsound software**

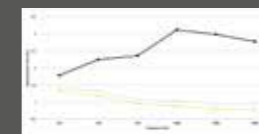

**Research & patents**



**"A" Class**

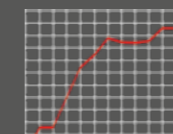

**Decibels reduction**



**Sound quality**



**100% sound absorbing**



**Strong, light & thin**



**Greenguard Gold**



**Eco-friendly**



**No formaldehyde**



**Hygiene & maintenance**



**CE**



**Fire resistance**



**Extreme conditions**



# SNOWCUSTOM TECHNOLOGY

**I** Snowcustom combina al meglio la tecnologia Snowsound Fiber Textiles dei tessuti fonoassorbenti abbinata alla densità differenziata del materiale fonoassorbente sottostante.

**EN** Snowcustom technology brings together Snowsound Fiber Textiles sound-absorbing fabric coverings with sound-absorbing underlays of variable density.

**F** Snowcustom réunit les qualités de la technologie Snowsound Fiber Textiles des tissus phono-absorbants avec la densité différenciée du matériau phono-absorbant sous-jacent.

**D** Snowcustom kombiniert auf ideale Weise die Snowsound Fiber Textiles-Technologie der schallabsorbierenden Gewebe mit der variablen Dichte des darunterliegenden schallabsorbierenden Materials.

**E** Snowcustom combina la tecnología de los tejidos acústicos Snowsound Fiber Textiles con la densidad variable del material fonoabsorbente del interior del panel.



**Download technologies brochure**



Clicca e scarica il pdf.

Click and download pdf file.

## Acoustic performance “A Class”

**I** I pannelli Snowcustom Technology sono stati testati in camera riverberante secondo la norma UNI EN ISO 354 ottenendo la “Classe di Assorbimento Acustico A” in accordo con la norma UNI EN ISO 11654.

**EN** Snowcustom Technology panels were tested in a reverberation room according to UNI EN ISO 354 standards obtaining “Class A sound absorption” to UNI EN ISO 11654 standards.

**F** Les panneaux Snowcustom Technology ont fait l’objet de tests en chambre réverbérante conformément à la norme UNI EN ISO 354, obtenant la “classe d’absorption acoustique A” selon la norme UNI EN ISO 11654.

**D** Die Snowcustom Technology Paneele wurden gemäß der Norm UNI EN ISO 354 in einem Hallraum getestet. Sie erhielten gemäß der Norm UNI EN ISO 11654 die Klassifizierung “Schallabsorption A”.

**E** Los paneles Snowcustom Technology se probaron en cámara reverberante conformemente a la norma UNI EN ISO 354 consiguiendo la “Clase A de Absorción Acústica” en virtud de la norma UNI EN ISO 11654.

ANDAMENTO DEL COEFFICIENTE DI ASSORBIMENTO ACUSTICO “ $\alpha_s$ ” PER TERZI D’OTTAVA  
One-third octave sound absorption coefficient curve “ $\alpha_s$ ”

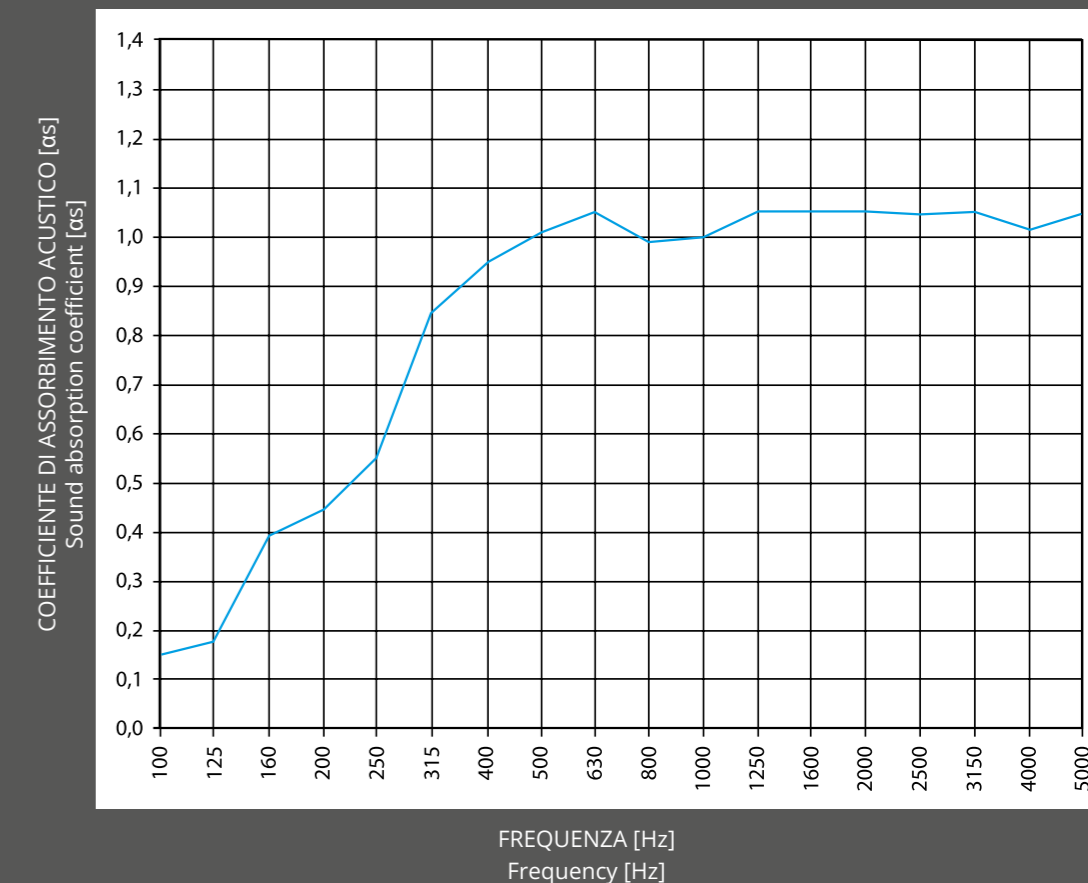

**I** Misura dell’assorbimento acustico in camera riverberante UNI EN ISO 354 (pannelli Snowcustom installati accostati e con intercapedine d’aria posteriore di 200 mm).

**EN** UNI EN ISO 354 measures sound-absorbing power in a reverberation room (Snowcustom panels installed side by side and with an 200 mm rear air space).

# Products dimensions & colours



**Download  
dimensions &  
colours brochure**



Clicca e scarica  
il pdf.

Click and download  
pdf file.