

Technical specification

- 1 Ceiling** - upholstered, equipped with lighting and exhaust fans
- 2 Upholstered wall** - full, 75 mm thick, upholstered on both sides, acoustic filling with sound isolation properties
- 3 Columns** - 75x75 mm, powder coated
- 4 Shelf** - 12 mm MDF, colour: black, can be mounted only to upholstered walls with 1000mm width.
- 5 Aluminium strips** - 5 mm thick
- 6 Glass wall** - toughened glass, 6 mm thick
- 7 Glass door** - toughened glass, 8 mm thick, equipped with hinges, handle with a lock and gaskets system improving the acoustic properties of the booth
- 8 Floor** - melamine plate + acoustic covering (21mm thickness), colour: graphite - option with additional fee
- 9 Fans:**
 - in - take (near the floor) - can be turned on and off, with adjustable fan speed. The exact location can be found on the shop drawings.
 - exhaust - integrated with the ceiling lamp

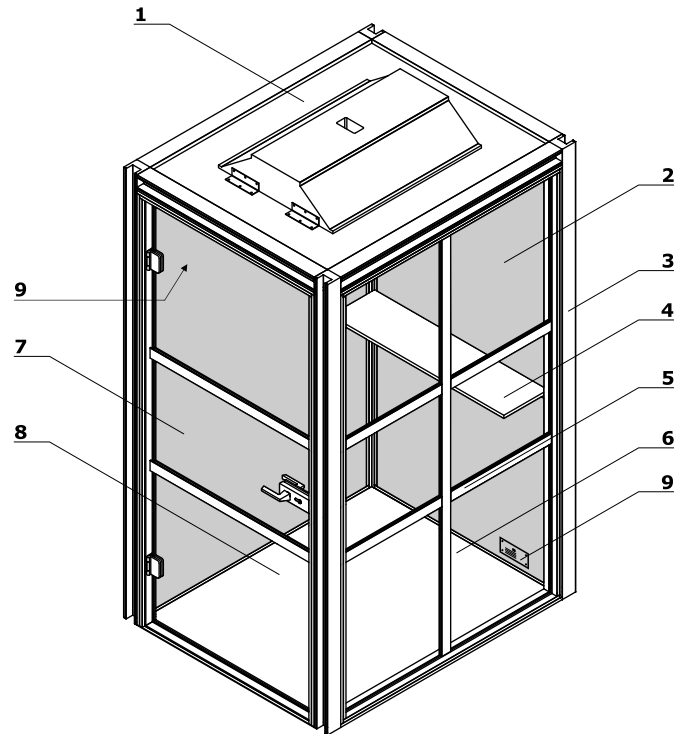

Attention! In standard the booth has no floor.

Configuration examples

HK01

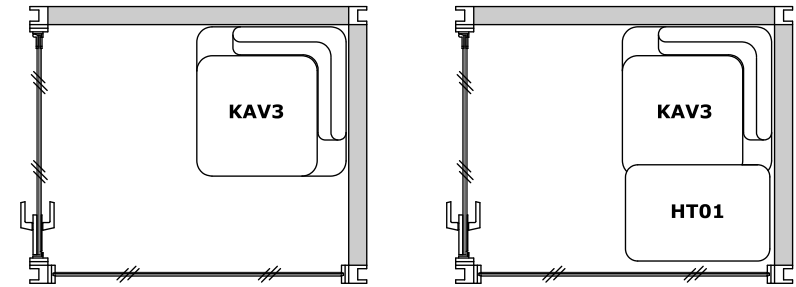

HK021

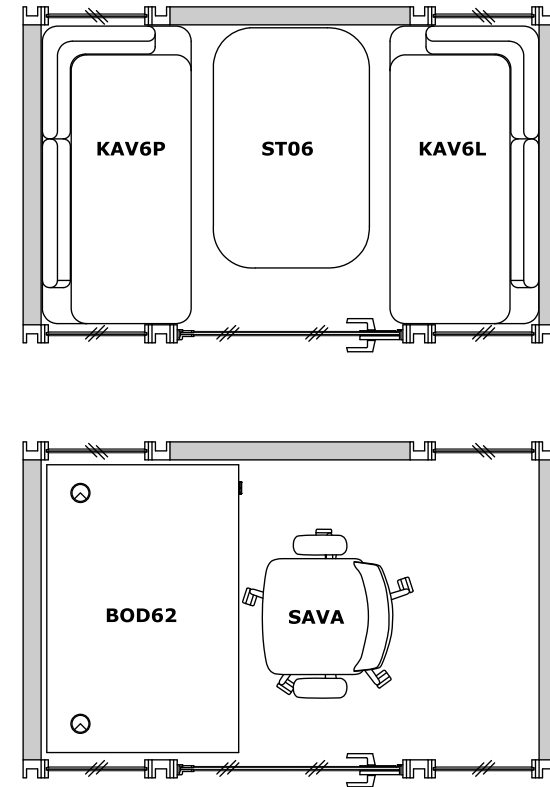

Configuration examples

HK03

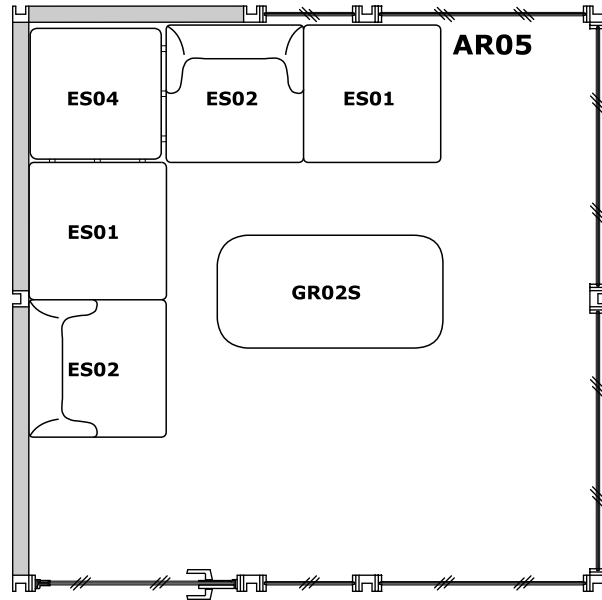
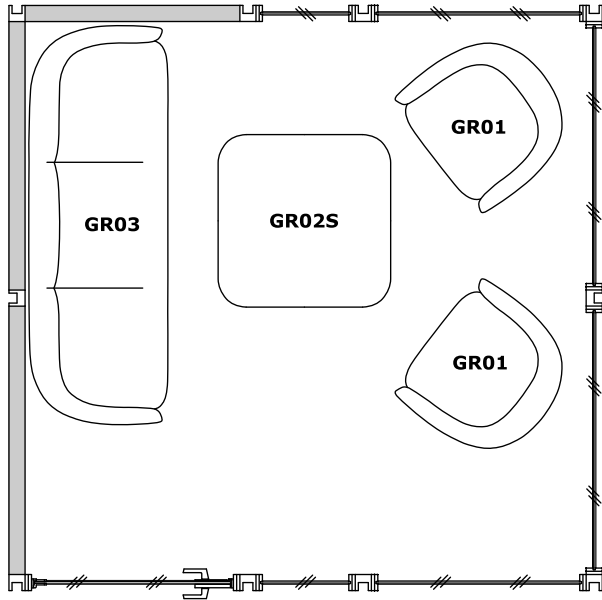
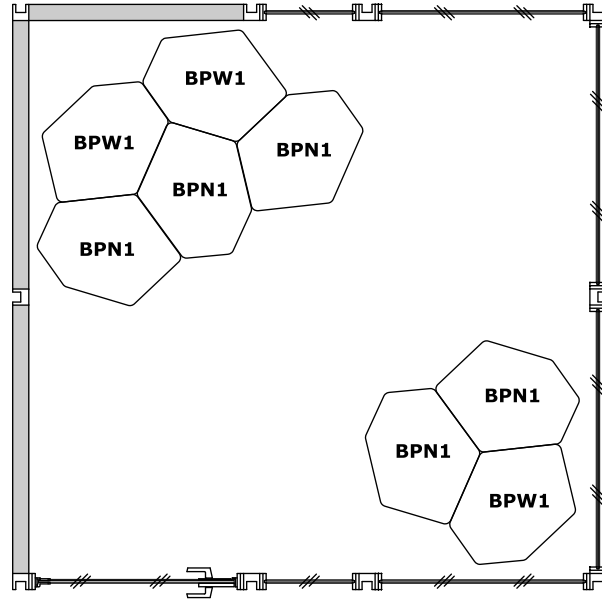
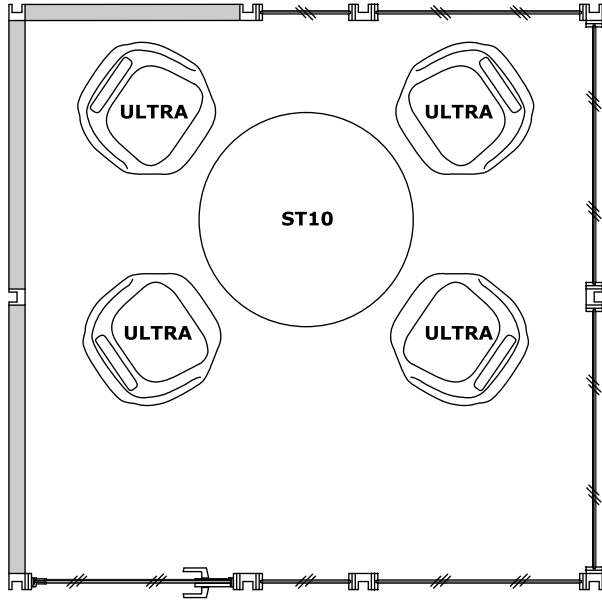







Dimensions (mm)

Mediabox location

1 Mediabox - 2x230V + 1xUSB + 1xUSB type C

- A** - on the left wall near the floor
- B** - on the right wall near the floor
- C** - on the shorter wall above 740mm height

Legend:

-  in - take fans (near the floor) can be turned on and off, with adjustable fan speed. - Attention! It is suggested not to block fans to ensure the proper airflow rate
-  motion sensor (activates the exhaust fans and lighting)
-  wireless light switch - which can be situated in any place
-  left / right door option
-  sliding door
-  exhaust fans are integrated with the ceiling lamp

HK01

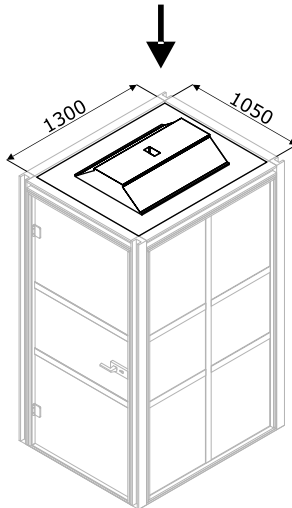
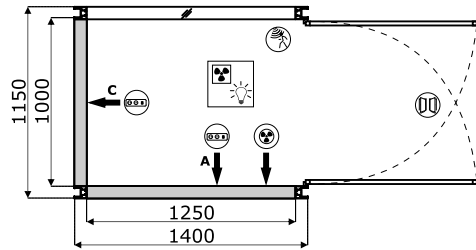

HK021

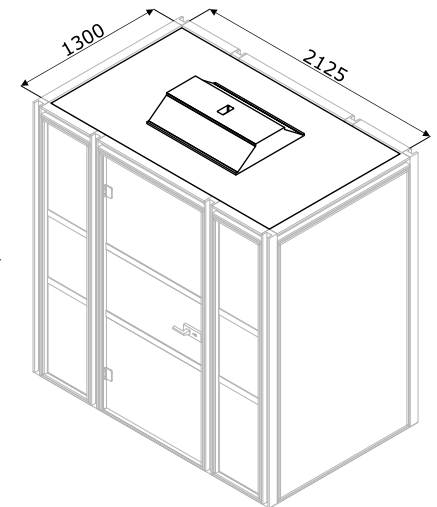
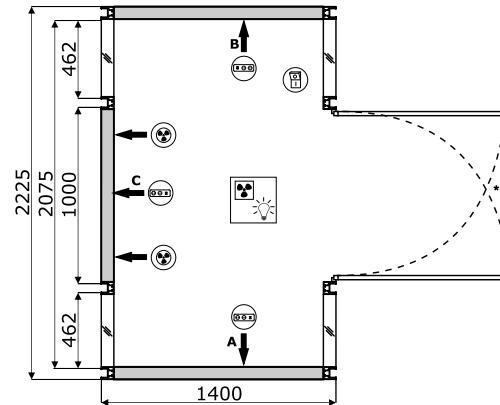

A, B

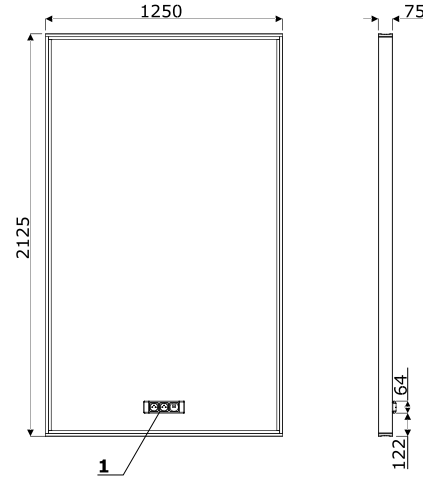

C

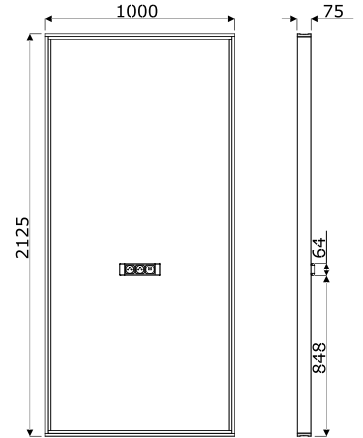

Dimensions (mm)

HK04

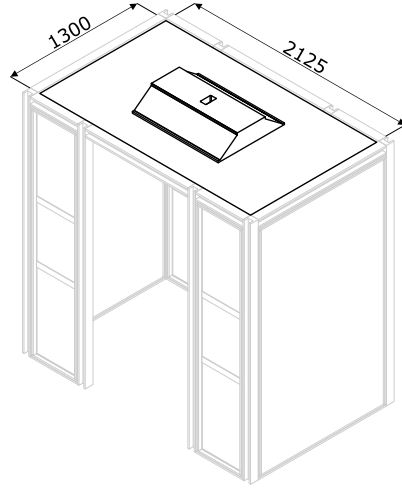
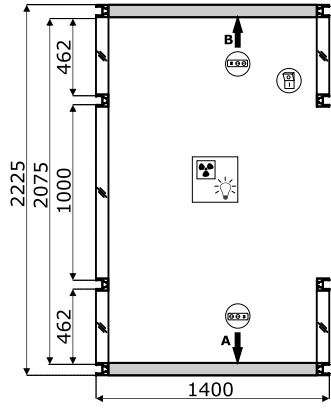



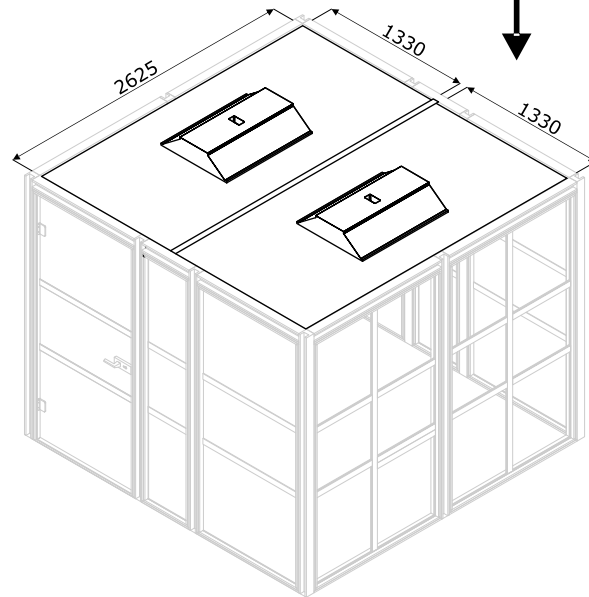
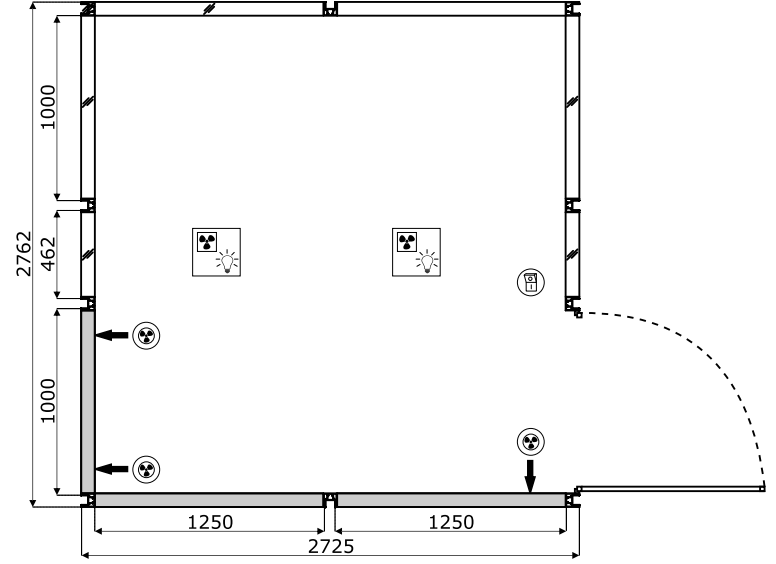

HK03

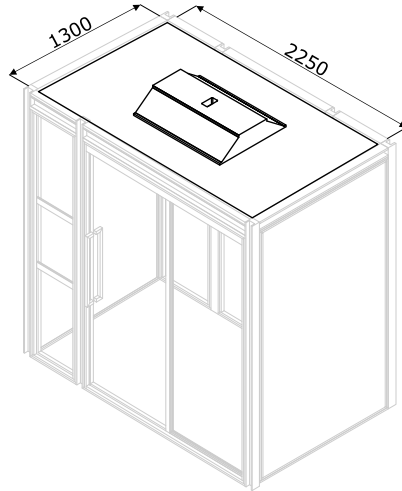
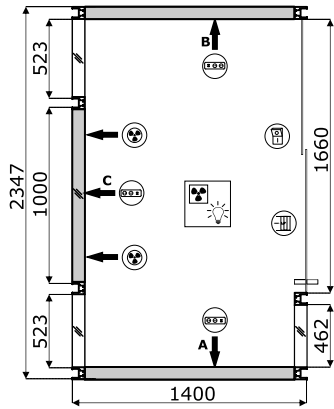

HK08



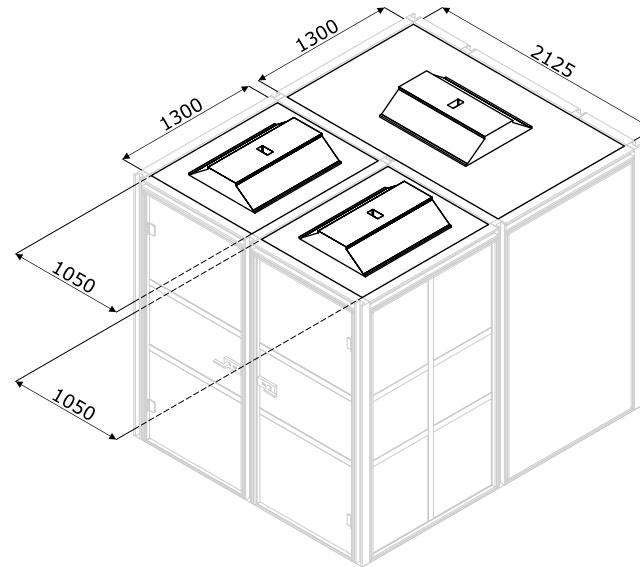
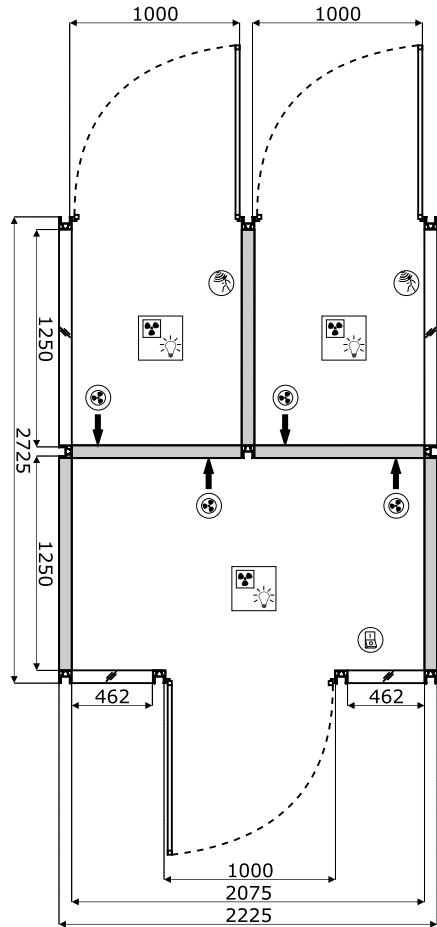

Dimensions (mm)**Legend:**

-  in - take fans (near the floor) can be turned on and off, with adjustable fan speed. - Attention! It is suggested not to block fans to ensure the proper airflow rate
-  motion sensor (activates the exhaust fans and lighting)
-  wireless light switch - which can be situated in any place
-  exhaust fans are integrated with the ceiling lamp



HK05

Dimensions (mm)**Legend:**

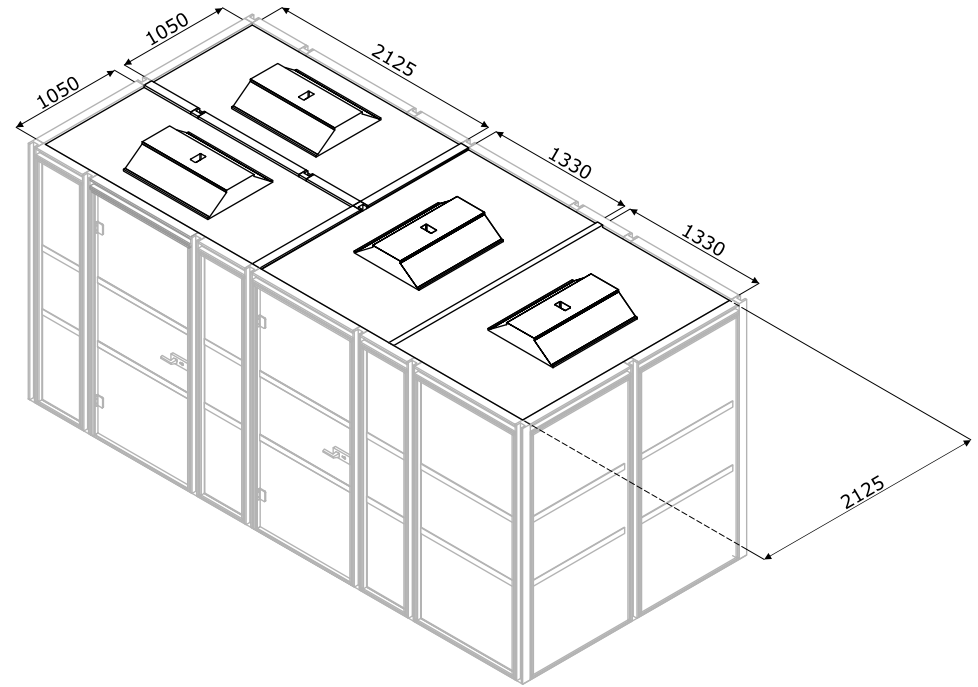
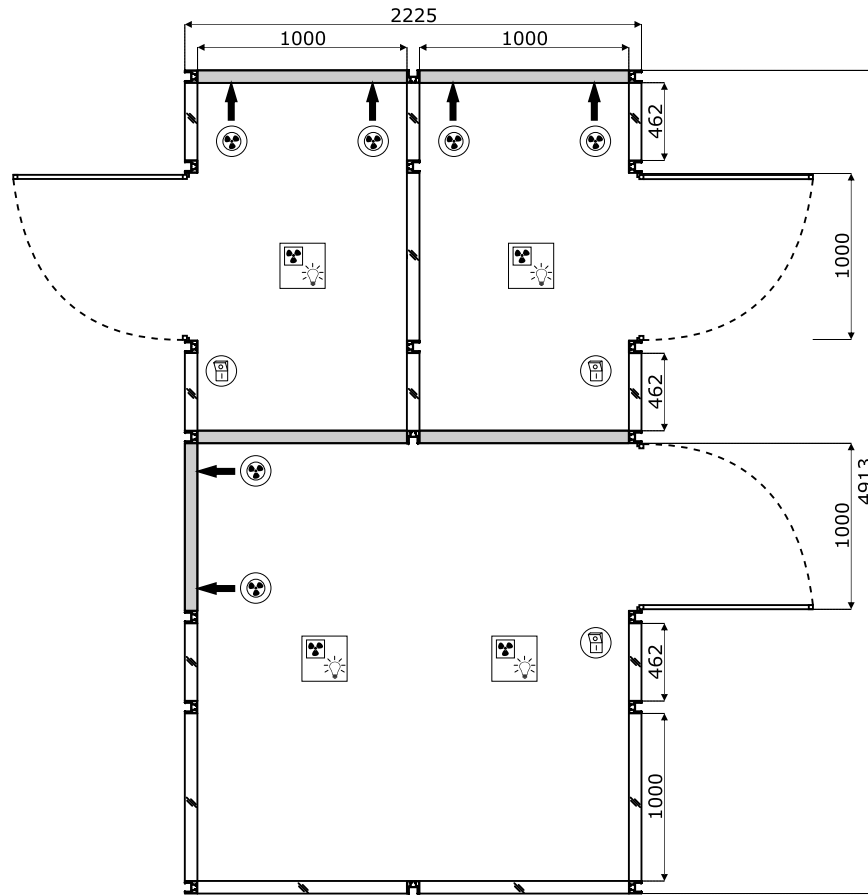
-  in - take fans (near the floor) can be turned on and off, with adjustable fan speed. - Attention! It is suggested not to block fans to ensure the proper airflow rate
-  wireless light switch - which can be situated in any place
-  exhaust fans are integrated with the ceiling lamp

HK06

Dimensions (mm)**Legend:**

-  in - take fans (near the floor) can be turned on and off, with adjustable fan speed. - Attention! It is suggested not to block fans to ensure the proper airflow rate
-  motion sensor (activates the exhaust fans and lighting)
-  wireless light switch - which can be situated in any place exhaust fans are integrated with the ceiling lamp

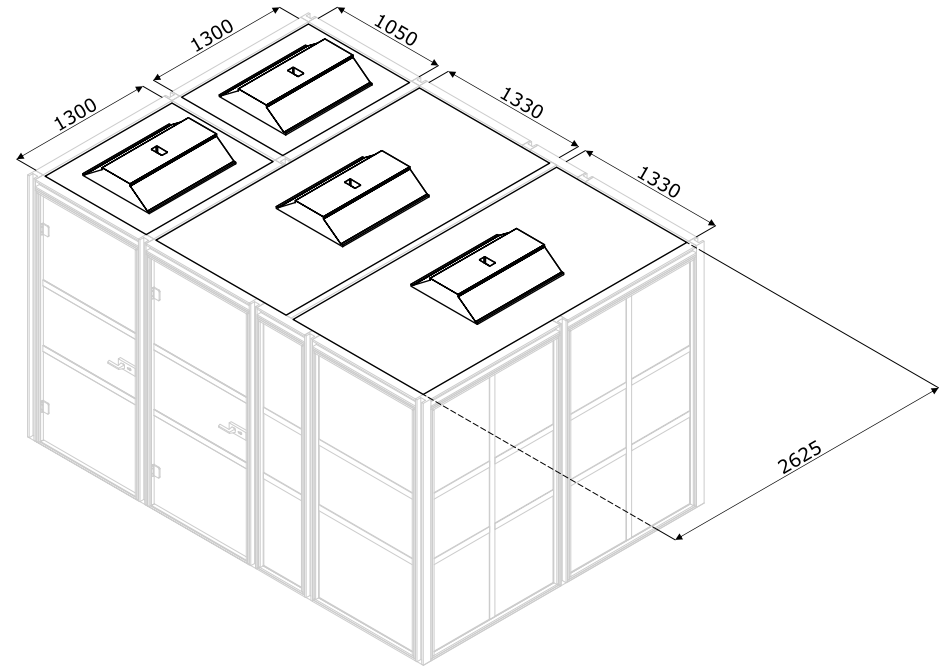
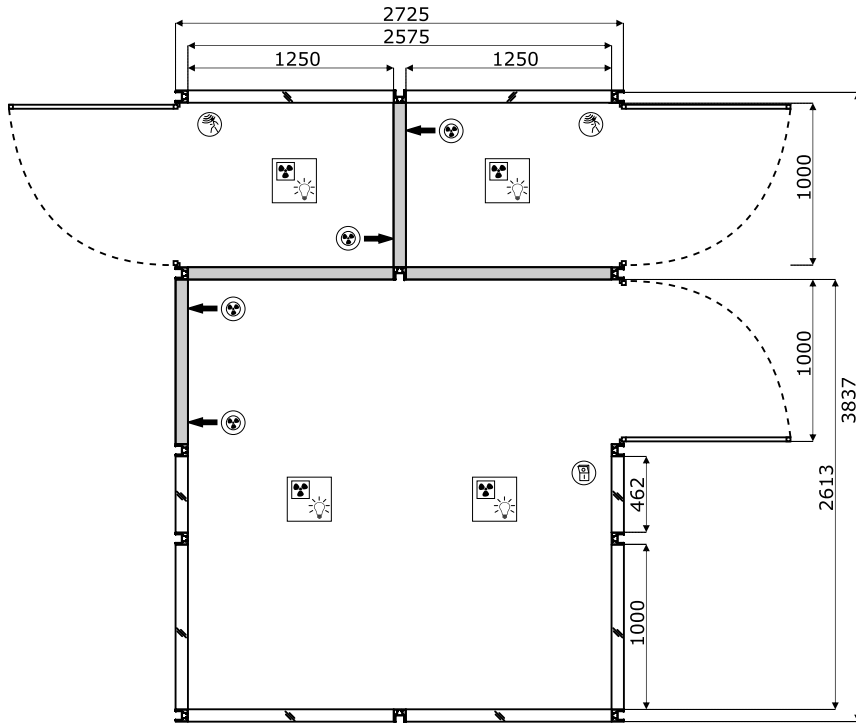
HK07

Table

- 1 Top** - MFC 18 mm, ABS edges 2 mm
- 2 Column** - powder coated steel, Ø 30mm
- 3 Base** - sheet metal, powder coated steel, 5 mm thick

