

PARTHOS

Technical information



Other documents available for this product

Cable management guidelines for conference and meeting tables

Quality standard

LST EN 15372:2017 (Level 2)
LST EN 1730:2012

10 year Warranty

See Warranty statement



Technical information

Types

- Meeting table (1)
- High meeting table (2)
- Coffee table (3)

Tabletop

MFC (melamine)

- 25 mm with 2 mm ABS edging;
- The corners of the tabletop are rounded: R=2 mm;
- With or without a cut-out for a grommet and power socket;
- Round and obround shaped.

MDF covered in HPL

- 26 mm MDF covered in HPL with sloping painted edges;
- Sloping painted edges: white, black or grey colour;
- The bottom edges of the tabletop are sloped 11°;
- With or without a cut-out for a grommet and power socket;
- Round and obround shaped.

Column structure

- The top cover is made of 36 mm MFC (melamine) with 2 mm ABS edging;
- Cover made of PET fiber board, 9 mm, with a vertical pattern;
- Welded metal frame made of 20x20 mm metal tube, 2 mm and 3 mm thickness of the metal sheets;
- Powder-coated metal;
- Base made of 36 mm MFC (melamine) with 2 mm ABS edging;
- Concrete counterweights;
- Adjustable height levelling feet, H=9 – 14 mm, 6 pcs.

Metal frame (under tabletop)

- Welded metal frame made of 40x20 mm metal tube;
- Powder coated metal.

1



2



3



PET felt cable tray (for two and three column tables)

- PET fiber board of a 9 mm thickness;
- Bent metal sheet of a 1 mm thickness;
- Powder-coated metal.

Electrical accessories

Rectangular grommet with a metal frame

- 16 mm MFC (melamine) or 17 mm MDF covered in HPL covers, matched with the tabletop;
- Grommet dimensions – 313x146x27 mm;
- Spot welded metal frame made of 1 and 3 mm thick metal sheets;
- Powder coated metal;
- Two opening directions.

Power unit (for one column tables)

- Power unit 100 – 240 V;
- Power unit standards: EU, FR, UK, CH, US;
- The hardwired power cord to GST18i3 1300 mm.

Available configurations of the power units (for one column tables)

- 3 x AC power sockets;
- 2 x AC power sockets, USB fast charger (USB fast charger type-A and type-C (5A));
- 3 x AC power sockets, wireless charger (10W) (except US market);
- 2 x AC power sockets, 1 x USB fast charger type-A and type-C (5A), wireless charger (10W) (except the US market).

Power units (for two and three column tables)

- Power socket 100 – 240 V;
- Power socket standards: EU, FR, UK, CH, US.

Available configurations of power units (for two and three column tables)

- 3-GANG – 3 x AC power sockets (except the US market);
- 3-GANG – 2 x AC power sockets and 1 LAN outlet (CAT6 RJ45) with a 2 m fly-lead;
- 3-GANG – 2 x AC power sockets and 1 x USB fast charger type-A and type-C;

- 3-GANG – 1 x AC power socket and 1 x USB fast charger type-A and type-C (5A), 1 LAN outlet (CAT6 RJ45) with a 2 m flylead.
- 4-GANG – 3 x AC power sockets and 1 x USB fast charger type-A and type-C (5A) (only for US market);
- 4-GANG – 3 x AC power socket and 2 x RJ45 socket (only for the US market);
- 4-GANG – 3 x AC power sockets and 1 x HDMI socket (only for the US market);
- 4-GANG – 2 x AC power sockets, 1 x USB fast charger type-A and type-C (5A), 1 x HDMI, 2 x LAN (only for the US market).

Power supply cables

- AC plug – GST18i3 female connector;
- AC plug standards: EU, UK, FR, CH, US;
- Cable lengths: 1 m and 3 m;
- Cable core: 1,5 mm² (EU, FR, UK, CH);
- Inline overcurrent protection (OCP 10A) (for the CH market);
- Cable core: 14AWG (for the US market);
- Inline overcurrent protection (OCP 15A) (for the US market);
- Inline overcurrent protection fulfils the statutory requirements: in the USA for more than 3 sockets, in Switzerland for more than 1 socket;
- Black colour.

Extension cables

- GST18i3 female connector – GST18i3 male connector;
- Cable lengths: 1 m, 2 m and 3 m;
- Cable core: 1,5 mm² (EU, FR, UK, CH);
- Cable core: 14AWG (for the US market)
- Black colour.

Extension cables sets (for two and three column tables)

- Distributor block: GST18i3 1-2 block (1 IN (male), 2 OUT (female));
- Extension cables: GST18i3 female connector – GST18i3 male connector;
- Cable lengths: 1 m, 2 m or 3 m.

Range

Meeting tables

4 / 5 seats

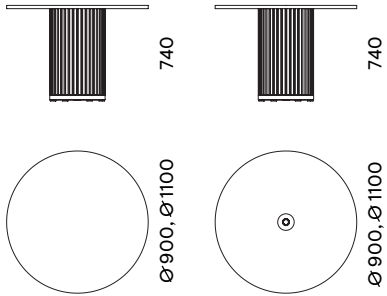

6 / 8 seats

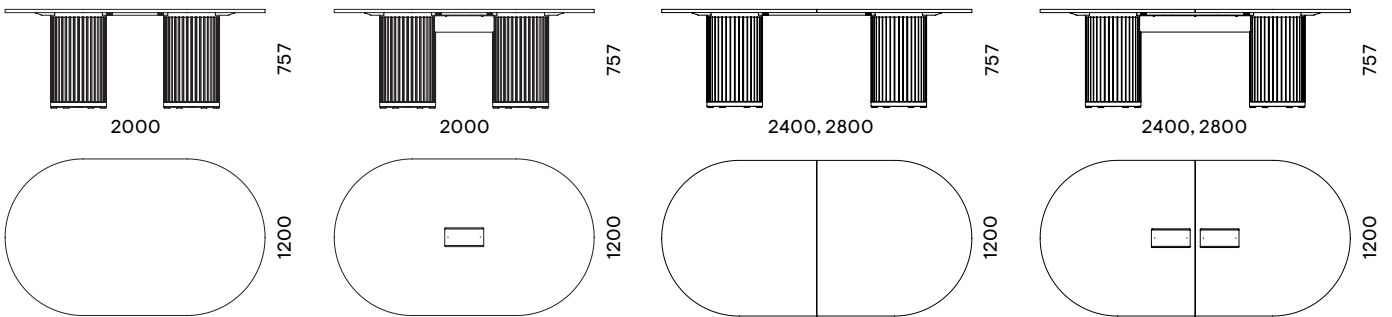

10 / 12 seats

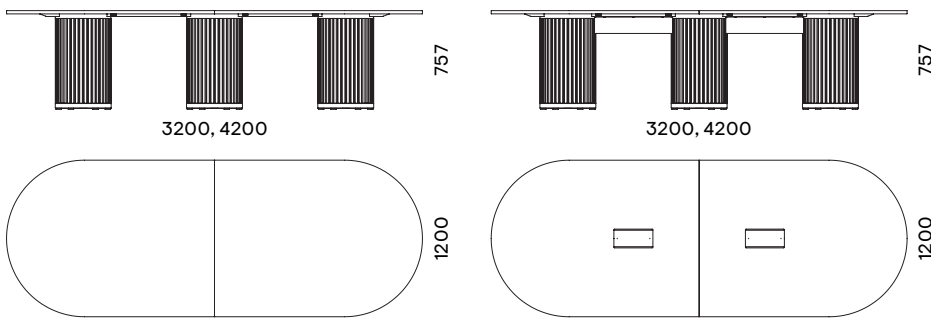

High meeting tables

4 seats

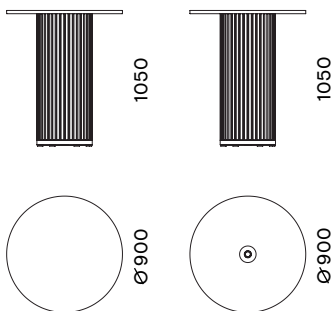

Coffee table

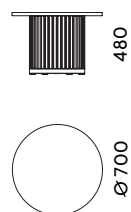

Additional information

- Two types of tabletops are available for the PARTHOS meeting tables: melamine with ABS edging; and HPL with sloping painted edges.



- MDF tabletops covered in HPL with sloping raw (painted) edges are especially sensitive to contact with hard surfaces like metal or wood, thus require extra caution when used with hard seating furniture.
- The metal table grommet and power units are not included. The metal table grommet, power unit, set of extension cables and power supply cable must be ordered separately.
- Power unit with a wireless function must be flipped to access the wireless charger.

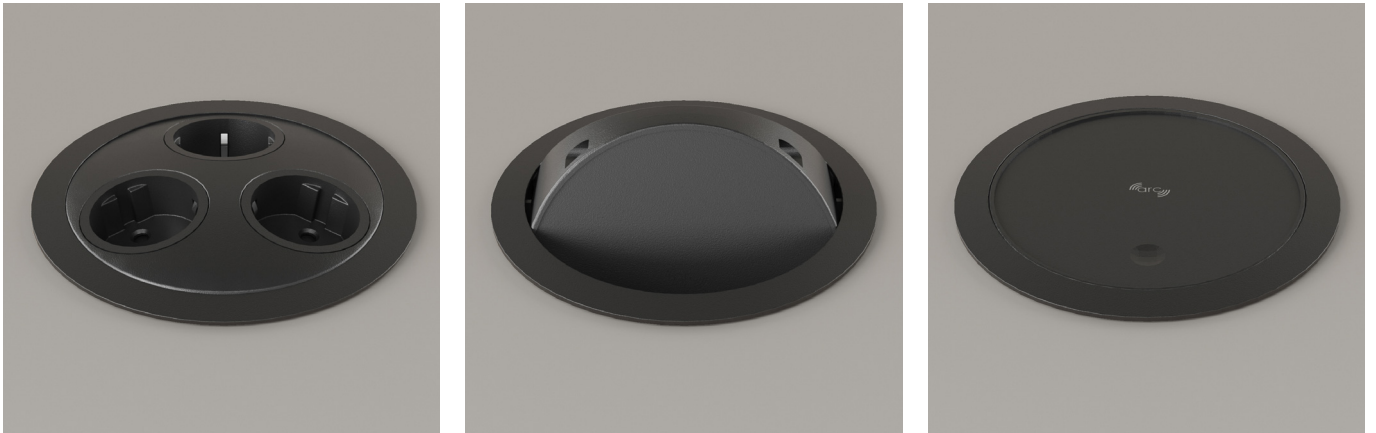

- Slight PET felt colour deviations can occur due to the use of recycled materials in the production of the product. Some undyed fibers may be present on the surface of the product.

PARTHOS

Cable management guidelines











Other documents available for this product

Technical information for PARTHOS meeting tables

! —————
All electrical installations should be done by a qualified person in accordance with local regulation.

↓ —————
Electric power limits (how many power sockets can be plugged into one main socket, without overloading it) vary from country to country. Please see the following information.

Market	Plug/power cable	Max power (V X A)	Power socket type	Recommended / Legal maximum number of sockets fed from 1 plug	National Standard	OCP* requirement
EU	Type E (16A)  To GST18i3 Female Cable core 1,5mm ²	230V x 16A = 3680W	Type F  Schuko Socket (German)	Maximum of 8 power sockets would be considered as safe and reasonable limit on a same shared circuit. More sockets (10-16) are possible if dedicated circuit is used only for office equipment such as laptops, tablets, phone chargers (less than 200W). Although this fully depends on the load of the equipment on a circuit as whole.	N/A	N/A
FR	Type E (16A)  To GST18i3 Female Cable core 1,5mm ²	230V x 16A = 3680W	Type E  French/Belgian Socket	Maximum of 8 power sockets would be considered as safe and reasonable limit on a same shared circuit. More sockets (10-16) are possible if dedicated circuit is used only for office equipment such as laptops, tablets, phone chargers (less than 200W). Although this fully depends on the load of the equipment on a circuit as whole.	N/A	N/A
UK	Type G (13A)  To GST18i3 Female Cable core 1,5mm ²	230V x 13A = 2990W	Type G  UK Fused Socket (3,15A)	Maximum 6 fused (3,15A) power sockets can be fed from single starter cable in office and education environments.	BS 6396:2008+A1:2015 Electrical systems in office furniture and educational furniture	N/A
CH	Type J (10A)  To GST18i3 Female Cable core 1,5mm ²	230V x 10A = 2300W	Type J  Swiss socket	Maximum of 6 power sockets would be considered as safe and reasonable limit on a same shared circuit. More sockets (8-10) are possible if dedicated circuit is used only for office equipment such as laptops, tablets, phone chargers (less than 200W). Although this fully depends on the load of the equipment on a circuit as whole.	SEV 1011 Swiss national standard for plugs and sockets for domestic use and similar purposes	For units hardwired to a plug with 2 or more sockets being fed from it (10A OCP)
EU FR UK CH	To GST18i3 Female Cable core 1,5mm ²	3680W 3680W 2990W 2300W	Type A+C (25W)  Twin USB fast charger	EU – max 30 sockets FR – max 30 sockets UK – max 30 sockets CH – max 20 sockets	UL62368-1 Standard for Audio/video, information and communication technology equipment Part 1: Safety requirements	N/A

*Overcurrent protection. Please read further information in the next page.

Starter cables with overcurrent protection

Overcurrent protection (OCP) fulfils statutory requirements for Switzerland for more than 1 socket (SEV 1011).

OCP device is hardwired into starter cables and designed to open the internal contacts in the event of a current flow in excess of the rated current according to its time/current characteristics. This protects the device from damage, should a surge occur. It can also provide load side protection to devices that are connected to higher rated supply side circuits.

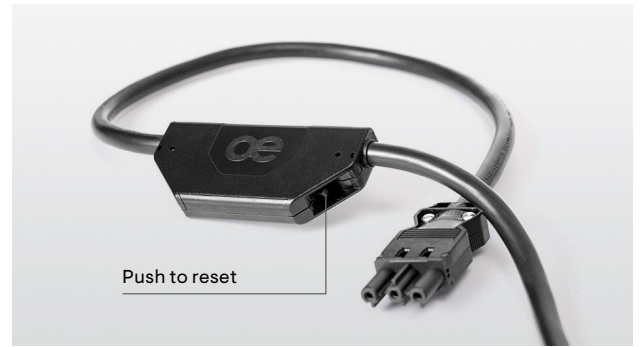

A thermal bimetallic strip, which has the advantage of being immune to high inrush currents and line transients, is heated by over current and deflects thereby releasing the latch mechanism. The contacts open even if the reset button is manually held in the closed position. This is known as trip-free mechanism. The contacts open and close with a positive snap action and the tripped state is clearly indicated by the extended projection of the reset button.



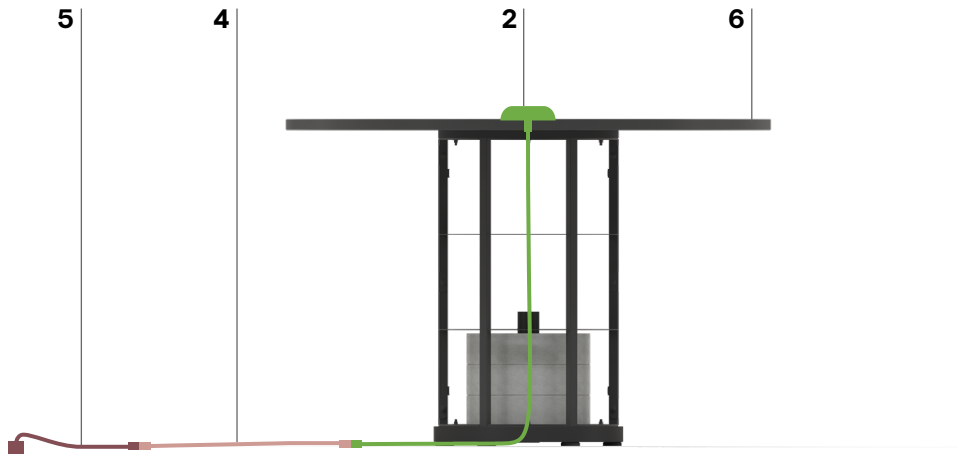

There are many solutions of how to manage electric power cables with GST18i3 connectors. See a few examples below.

Ordering example 1

CPA111 - Ø1100, H=740



Pricelist item's selection





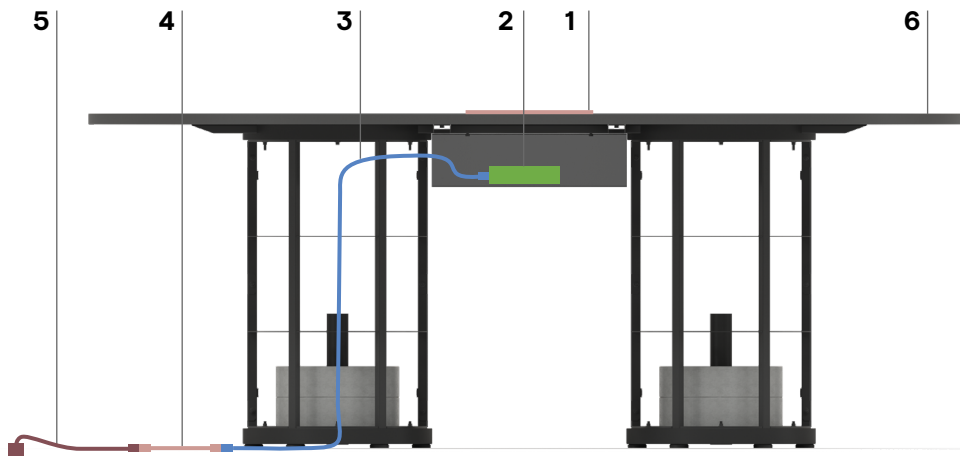

	Description	Code	Quantity (pcs.)
2	 Power unit	ZZZ379, ZZZ380, ZZZ381, or ZZZ382	1
4	 Extension cable (optional)	ZZZ348, ZZZ349 or ZZZ350	1
5	 Power supply cable	EU, UK, FR: ZZZ346 or ZZZ347 CH: ZCH001 or ZCH002	1
6	 Meeting table (5 seats) with cut-out for power unit	CPA111	1

Ordering example 2

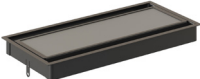
CPA221 - 2000x1200x758



Pricelist item's selection





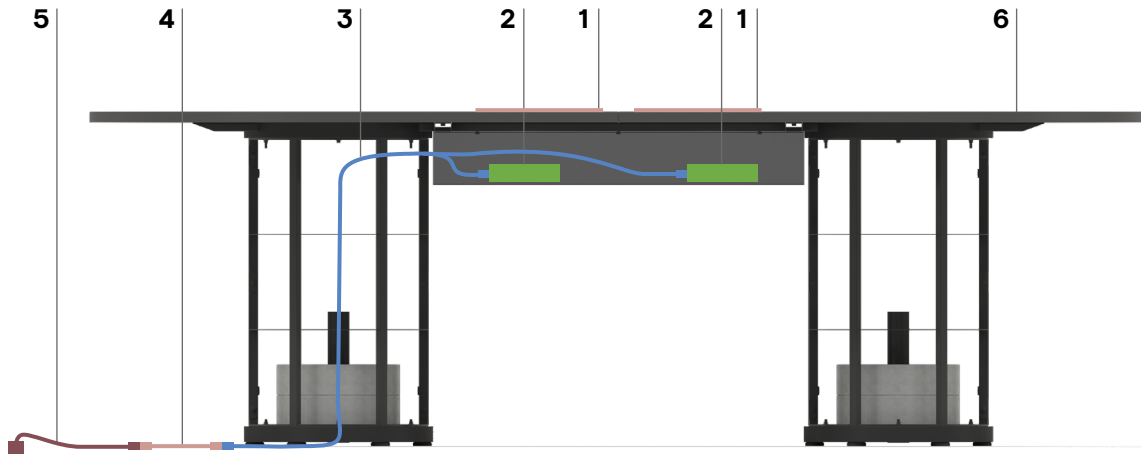

	Description	Code	Quantity (pcs.)
1	 Rectangular metal table grommet	ZPZ001	1
2	 Power unit	ZZZ386, ZZZ387, ZZZ388 or ZZZ389	1
3	 Extension cable, 2 m	ZZZ349	1
4	 Extension cable (optional)	ZZZ348, ZZZ349 or ZZZ350	1
5	 Power supply cable	EU, UK, FR: ZZZ346 or ZZZ347 CH: ZCH001 or ZCH002	1
6	 Meeting table (6 seats) with cut-out for rectangular metal grommet and PET felt cable tray (ZPZ001 must be ordered)	CPA221	1

Ordering example 3

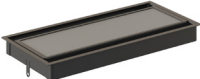
CPA223 - 2400x1200x758

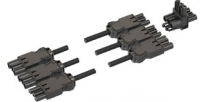

Pricelist item's selection





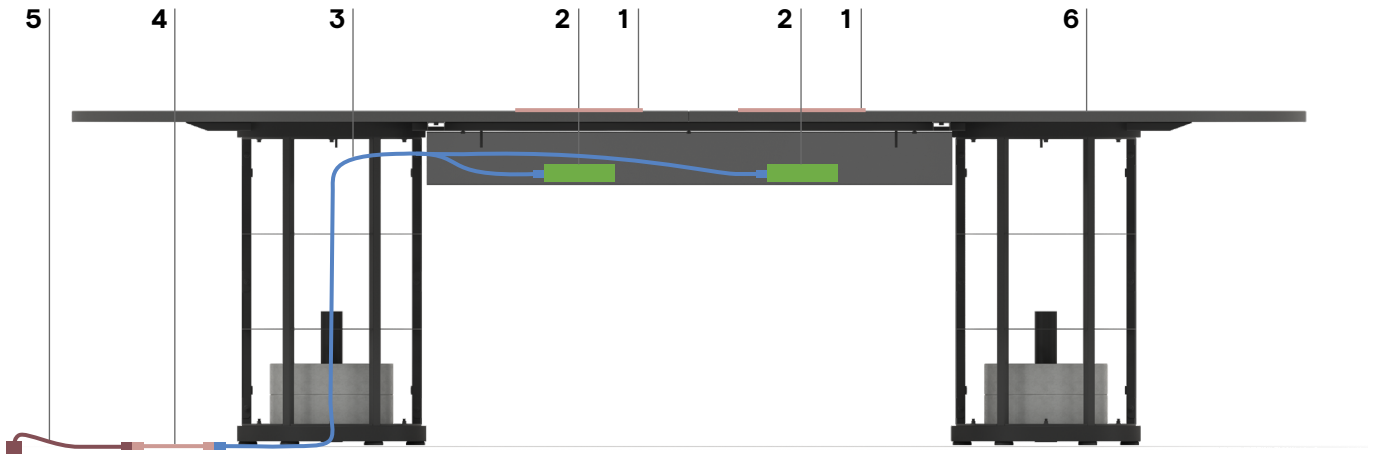

	Description	Code	Quantity (pcs.)
1 	Rectangular metal table grommet	ZPZ001	2
2 	Power unit	ZZZ386, ZZZ387, ZZZ388 or ZZZ389	2
3 	Extension cables set	ZZZ383	1
4 	Extension cable (optional)	ZZZ348, ZZZ349 or ZZZ350	1
5 	Power supply cable	EU, UK, FR: ZZZ346 or ZZZ347 CH: ZCH001 or ZCH002	1
6 	Meeting table (8 seats) with cut-out for rectangular metal grommet and PET felt cable tray (ZPZ001 must be ordered)	CPA223	1

Ordering example 4

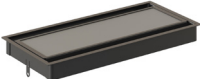
CPA225 - 2800x1200x758

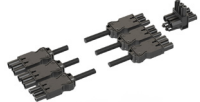

Pricelist item's selection





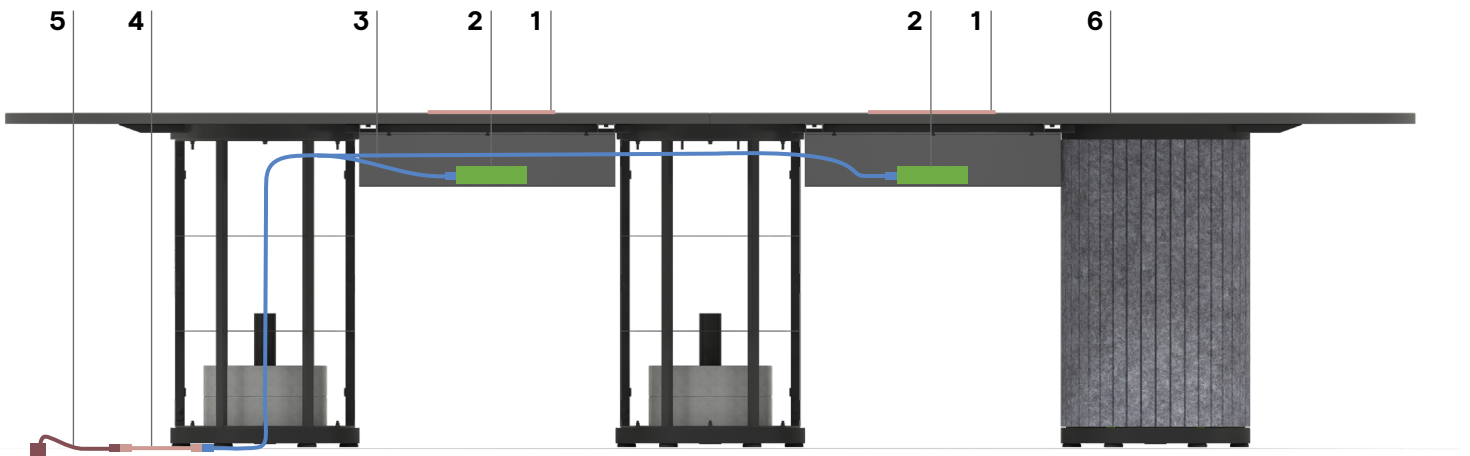

	Description	Code	Quantity (pcs.)
1	 Rectangular metal table grommet	ZPZ001	2
2	 Power unit	ZZZ386, ZZZ387, ZZZ388 or ZZZ389	2
3	 Extension cables set	ZZZ384	1
4	 Extension cable (optional)	ZZZ348, ZZZ349 or ZZZ350	1
5	 Power supply cable	EU, UK, FR: ZZZ346 or ZZZ347 CH: ZCH001 or ZCH002	1
6	 Meeting table (8 seats) with cut-out for rectangular metal grommet and PET felt cable tray (ZPZ001 must be ordered)	CPA225	1

Ordering example 5

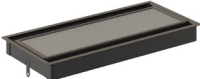
CPA331 - 3200x1200x758

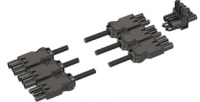

Pricelist item's selection





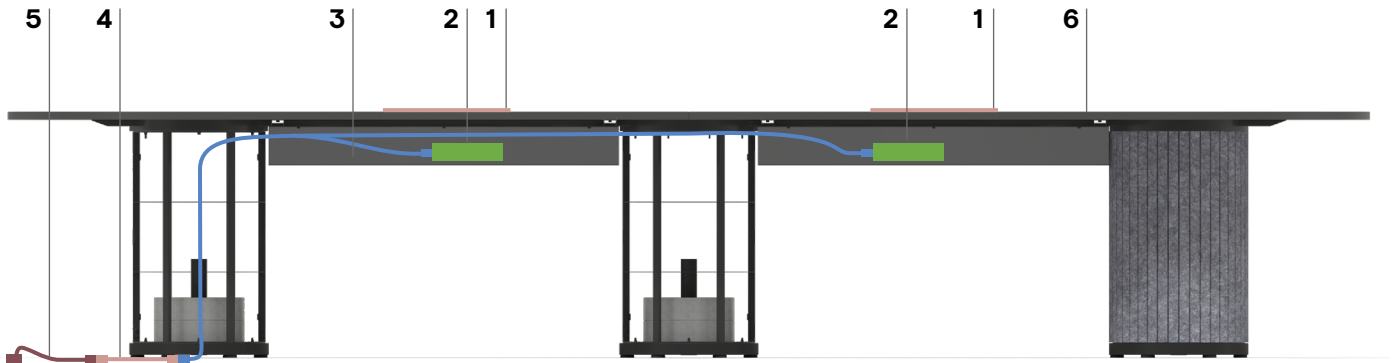

	Description	Code	Quantity (pcs.)
1	 Rectangular metal table grommet	ZPZ001	2
2	 Power unit	ZZZ386, ZZZ387, ZZZ388 or ZZZ389	2
3	 Extension cables set	ZZZ384	1
4	 Extension cable (optional)	ZZZ348, ZZZ349 or ZZZ350	1
5	 Power supply cable	EU, UK, FR: ZZZ346 or ZZZ347 CH: ZCH001 or ZCH002	1
6	 Meeting table (10 seats) with cut-out for rectangular metal grommet and PET felt cable tray (ZPZ001 must be ordered)	CPA331	1

Ordering example 6

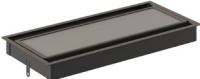
CPA341 - 4200x1200x758

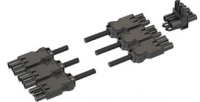

Pricelist item's selection

	Description	Code	Quantity (pcs.)
1 	Rectangular metal table grommet	ZPZ001	2
2 	Power unit	ZZZ386, ZZZ387, ZZZ388 or ZZZ389	2
3 	Extension cables set	ZZZ385	1
4 	Extension cable (optional)	ZZZ348, ZZZ349 or ZZZ350	1
5 	Power supply cable	EU, UK, FR: ZZZ346 or ZZZ347 CH: ZCH001 or ZCH002	1
6 	Meeting table (12 seats) with cut-out for rectangular metal grommet and PET felt cable tray (ZPZ001 must be ordered)	CPA341	1